

CHƯƠNG TRÌNH KC.05 - DỰ ÁN KC.05.DA.13

Trung Tâm Phát triển Công nghệ Ô tô

BỘ KHUÔN MẪNG SÀN XE

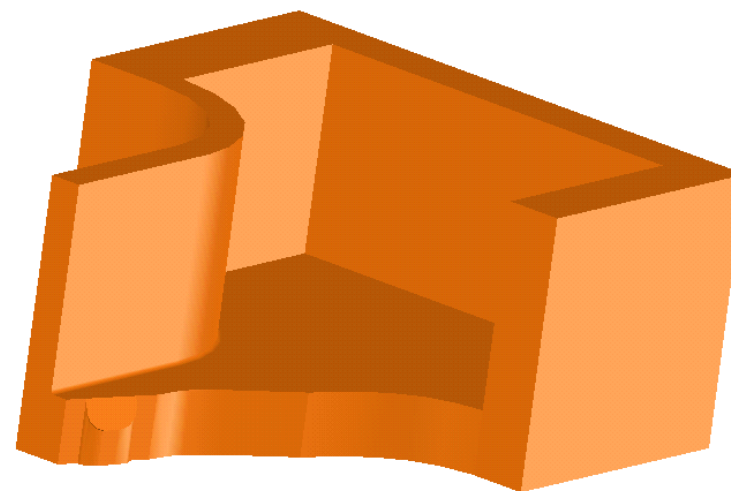
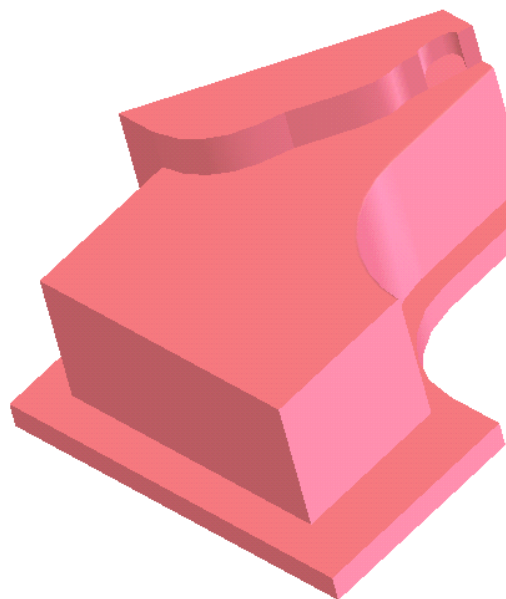

Hà Nội 6-2006

6091-20

Ký hiệu (Code)
K03-01-01-00

Tên chi tiết (Name of autopart)
KHUÔN KHUNG TRÁI TRƯỚC

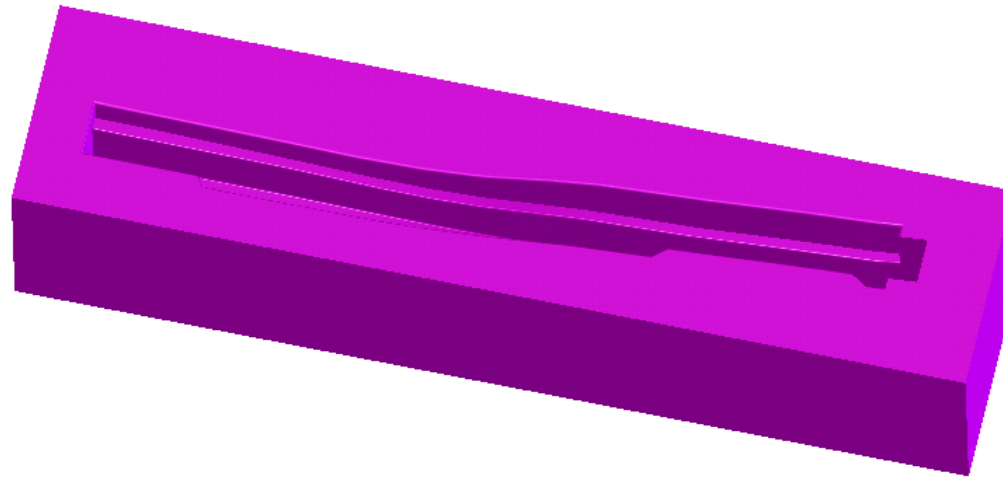
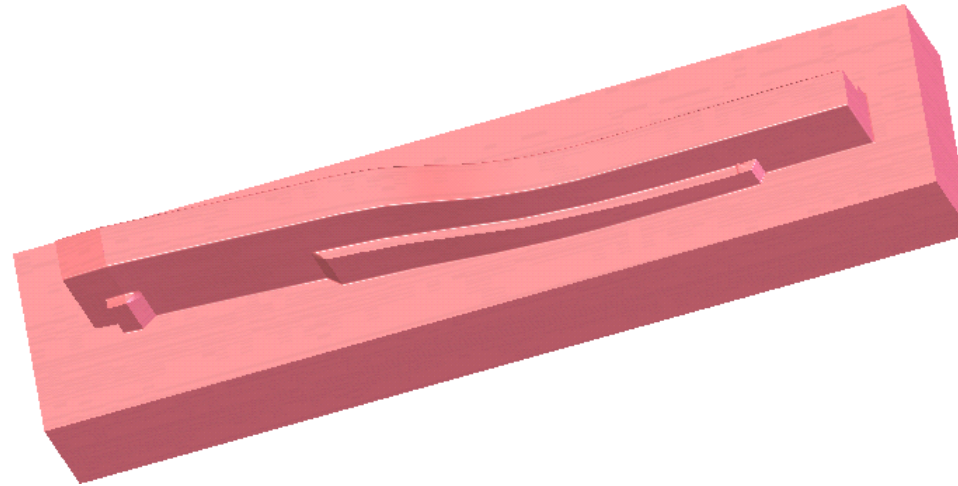

Ký hiệu (Code)
K03-01-01-01

Tên chi tiết (Name of autopart)
KHUÔN TẤM MẶT ĐẦU

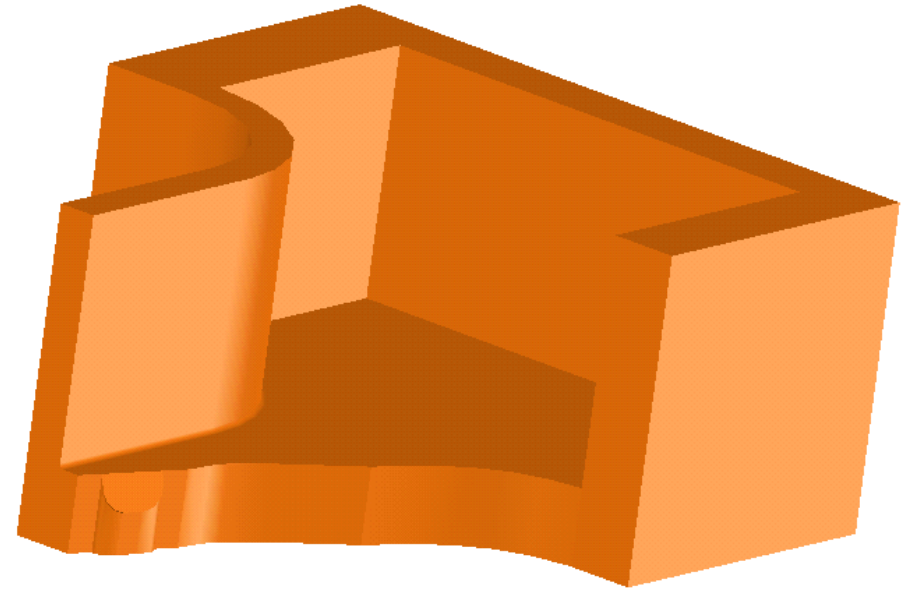
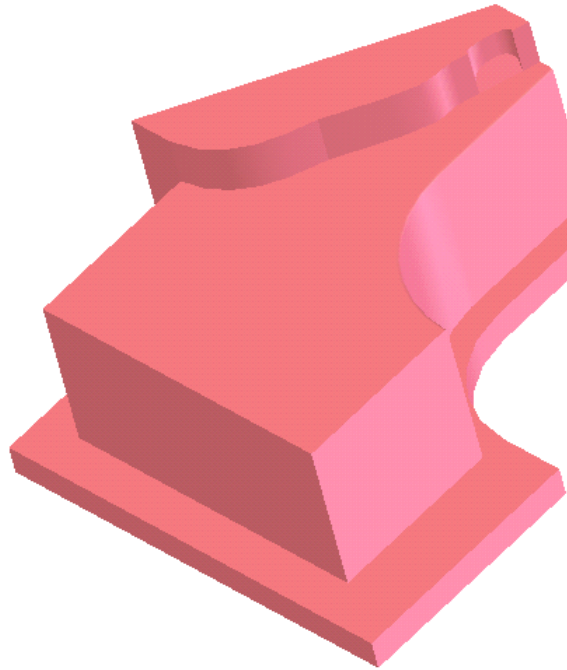

Ký hiệu (Code)
K03-01-01-02

Tên chi tiết (Name of autopart)
KHUÔN TAI MÓC

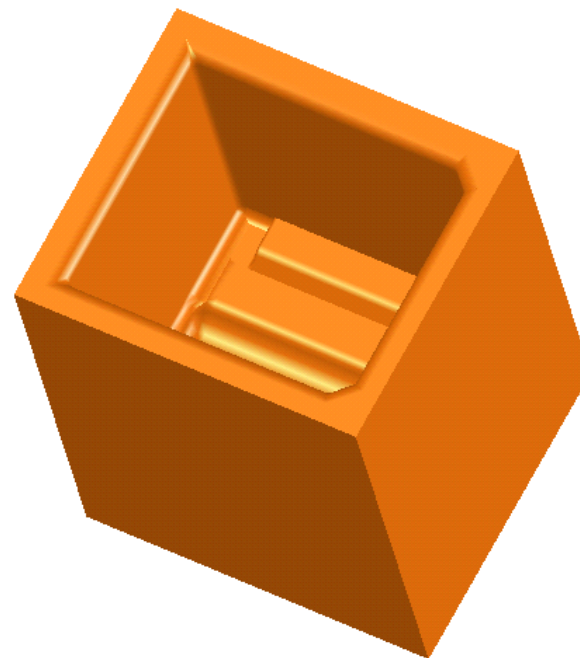
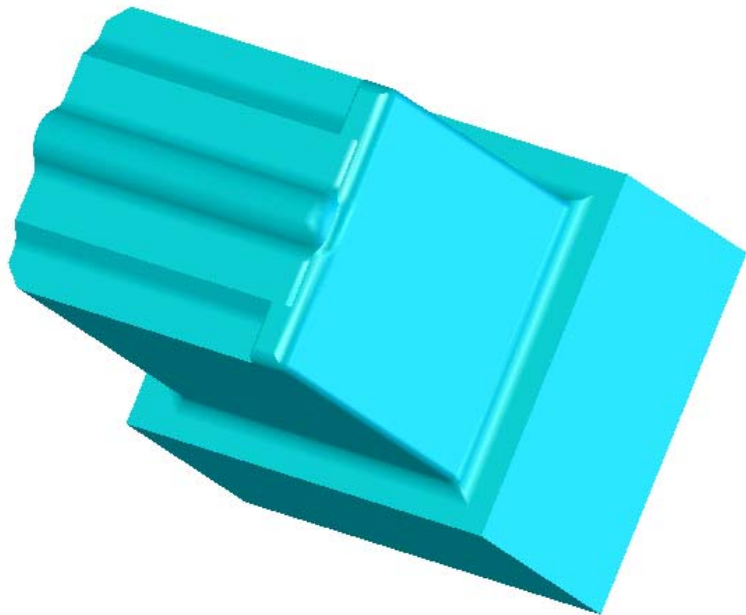

Ký hiệu (Code)
K03-01-01-03

Tên chi tiết (Name of autopart)
KHUÔN MÓC GÀI DÂY

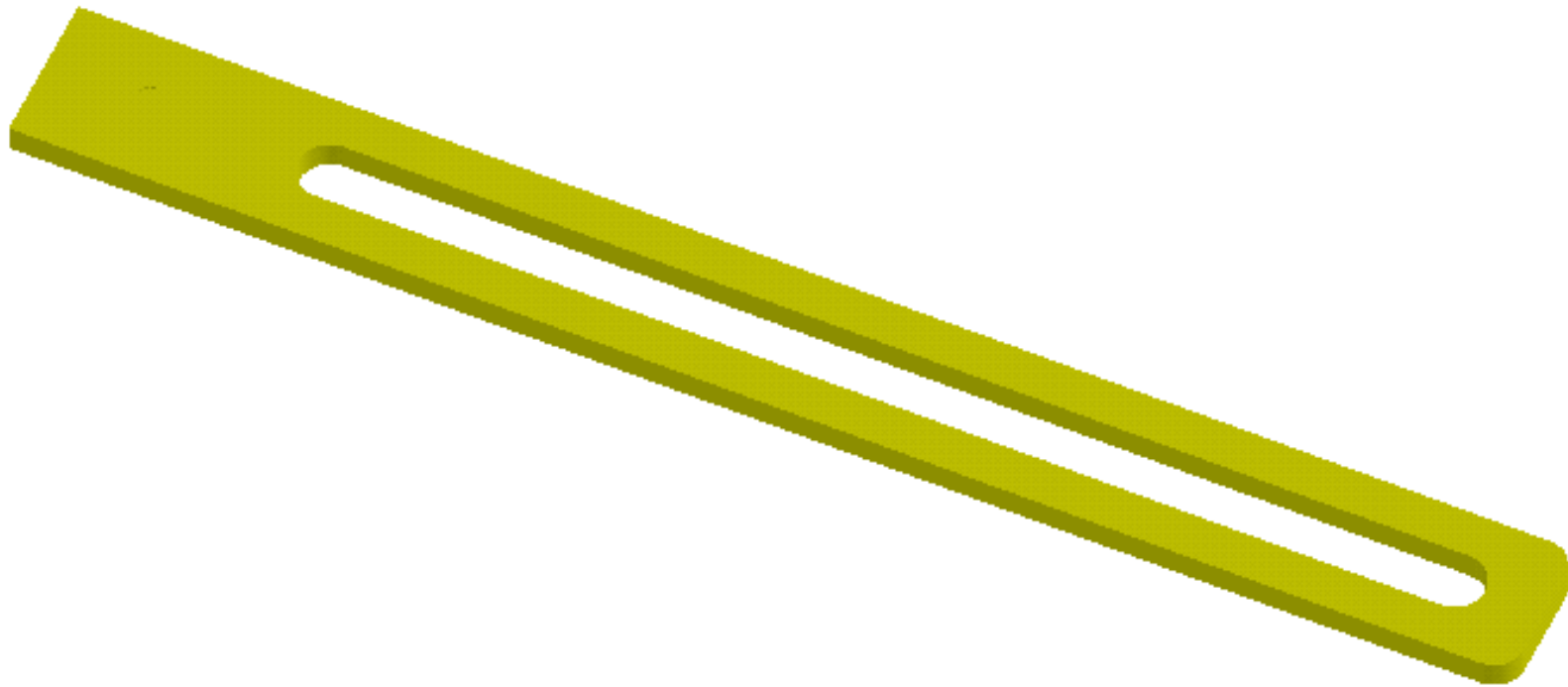

Ký hiệu (Code)
K03-01-02-00

Tên chi tiết (Name of autopart)
KHUÔN KHUNG PHẢI TRƯỚC

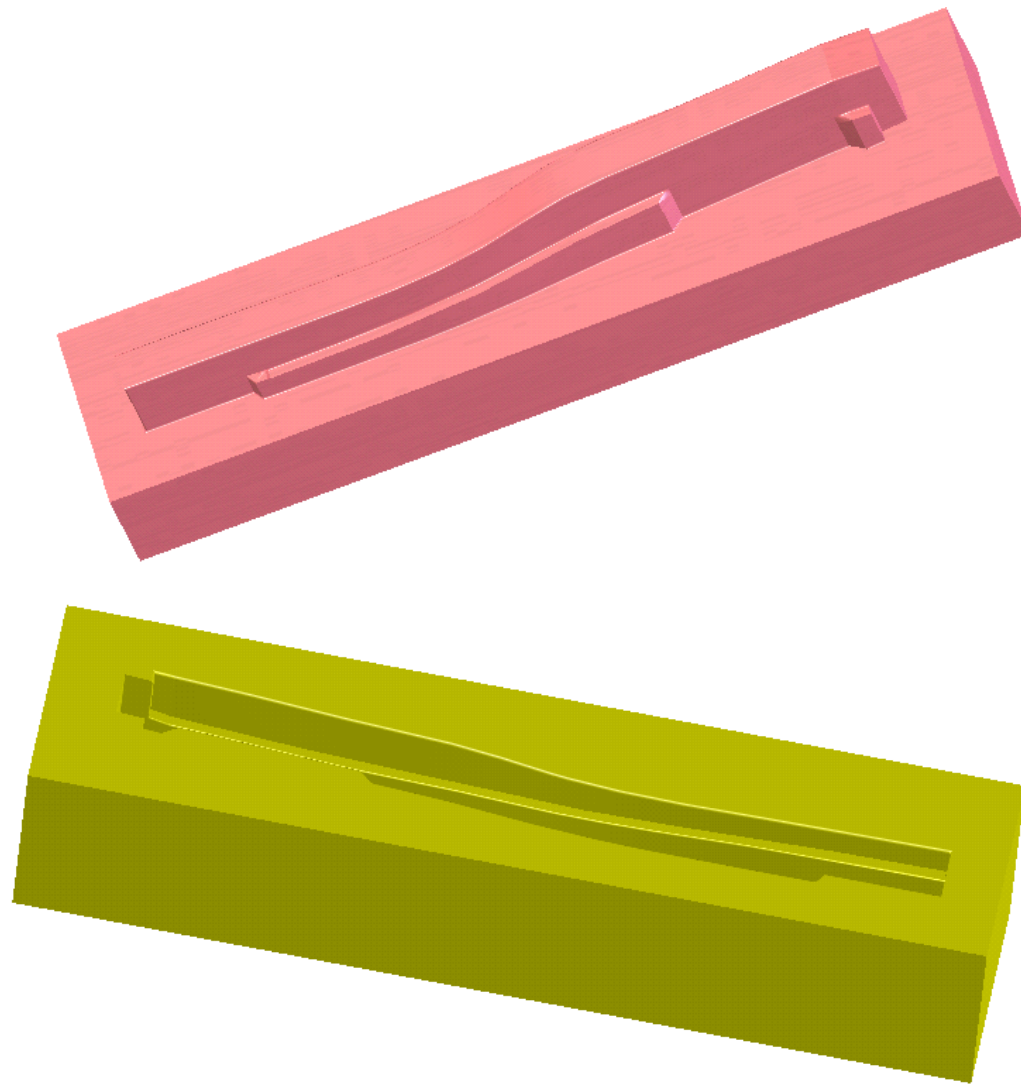

Ký hiệu (Code)
K03-01-02-01

Tên chi tiết (Name of autopart)
KHUÔN TẤM MẶT ĐẦU

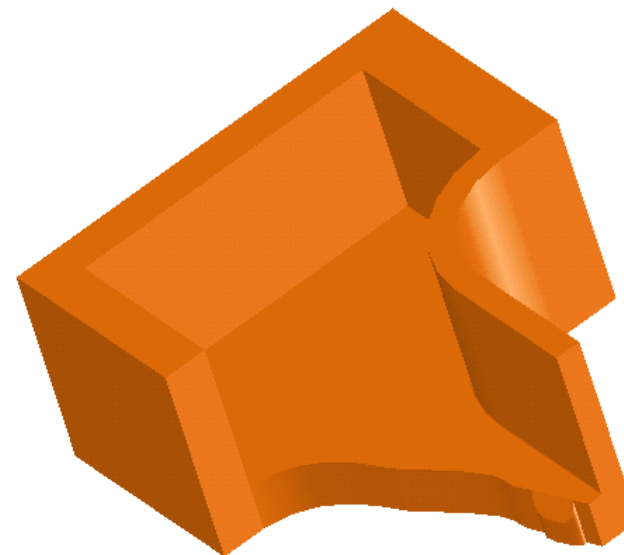
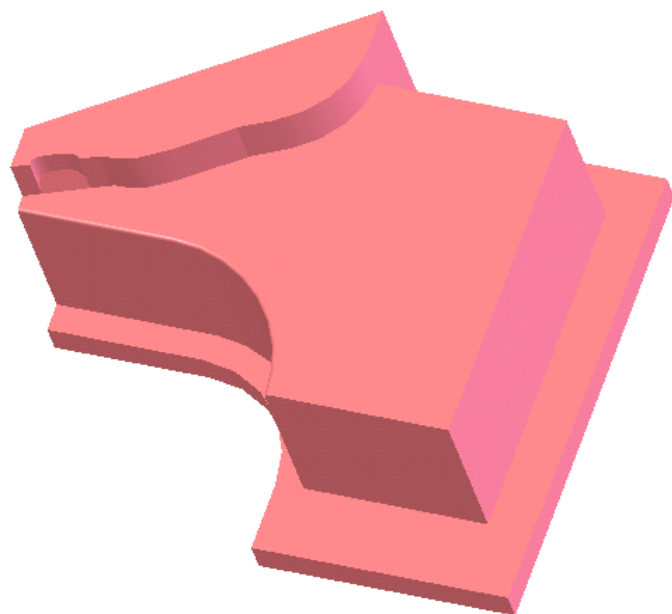

Ký hiệu (Code)
K03-01-02-01

Tên chi tiết (Name of autopart)
KHUÔN TAI MÓC

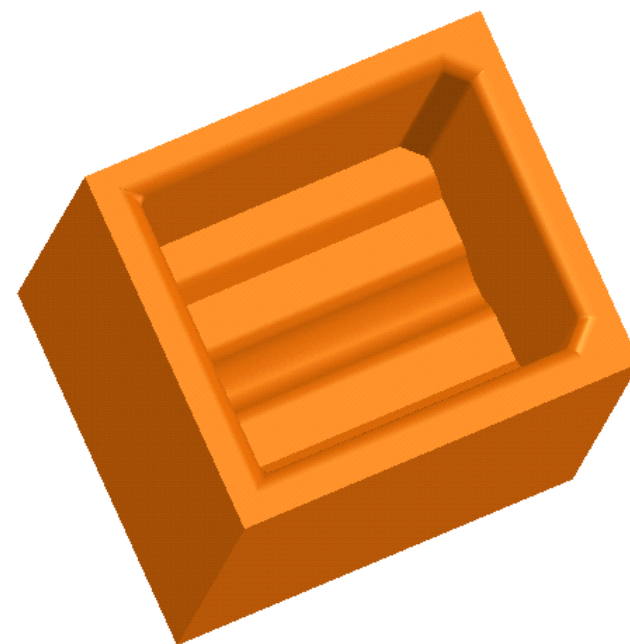
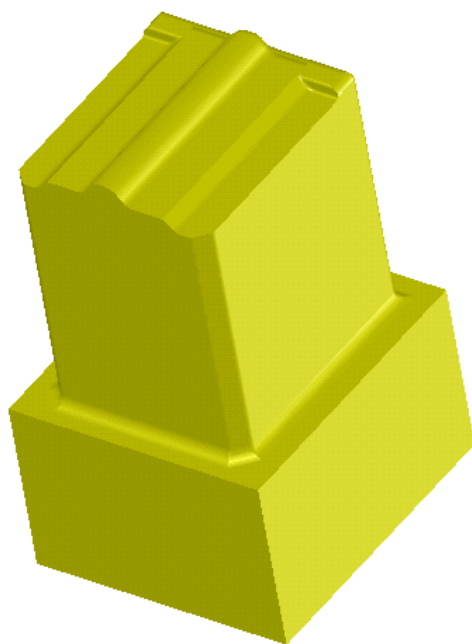

Ký hiệu (Code)
K03-01-03-00

Tên chi tiết (Name of autopart)
KHUÔN KHUNG TRÁI GIỮ

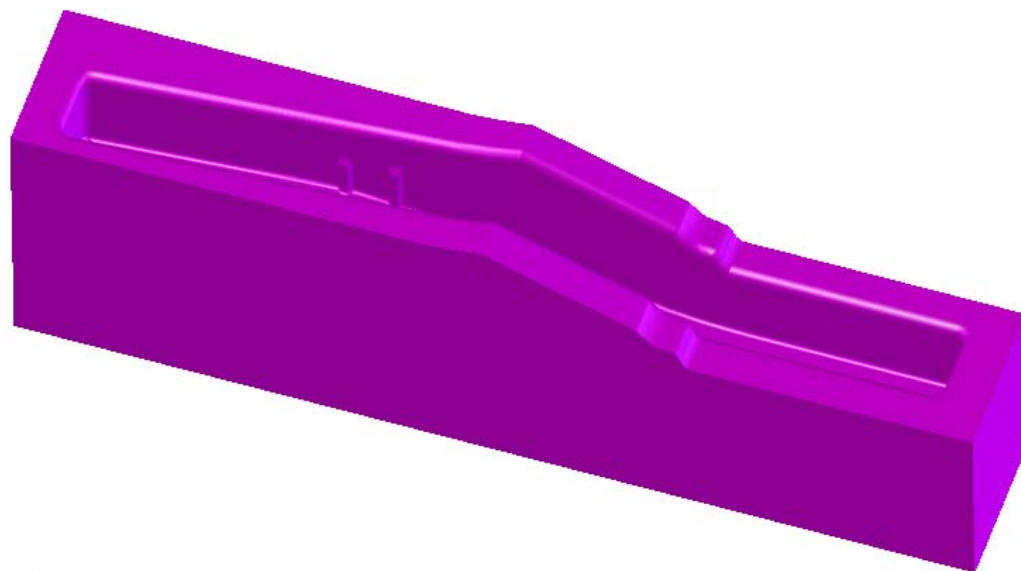
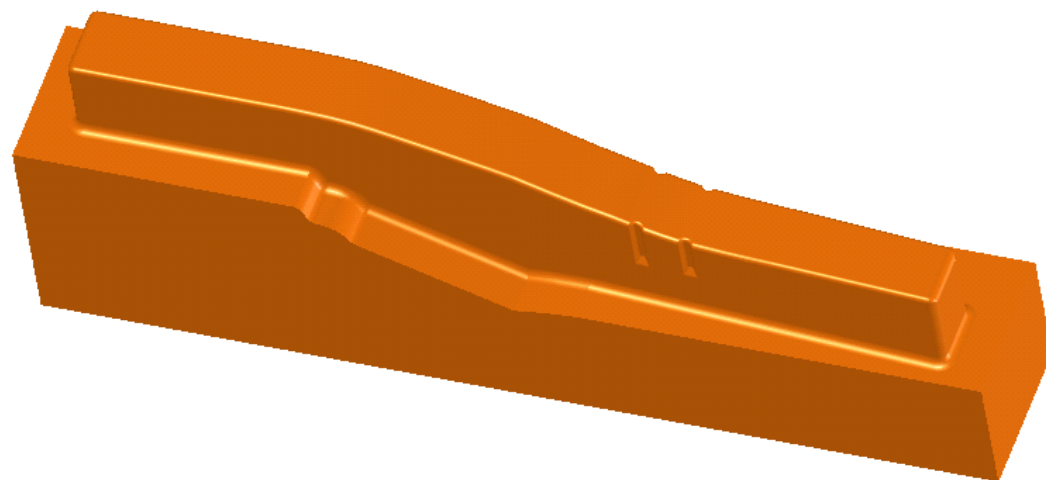

Ký hiệu (Code)
K03-01-03-01

Tên chi tiết (Name of autopart)
KHUÔN MIẾNG ĐỆM

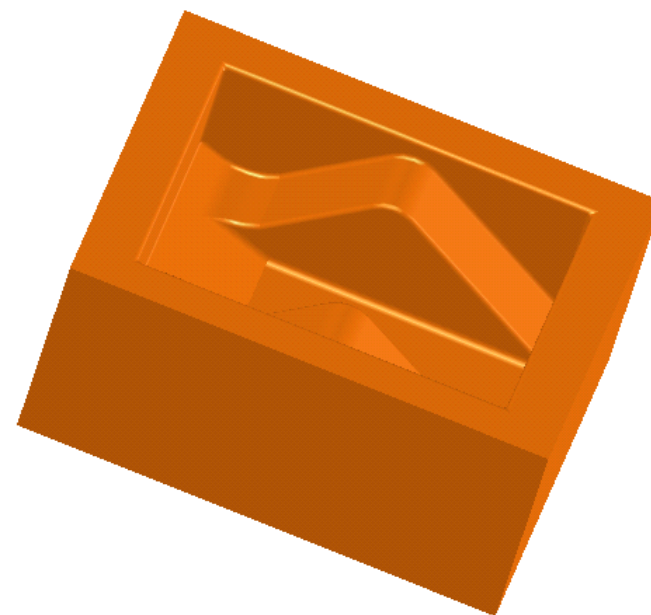
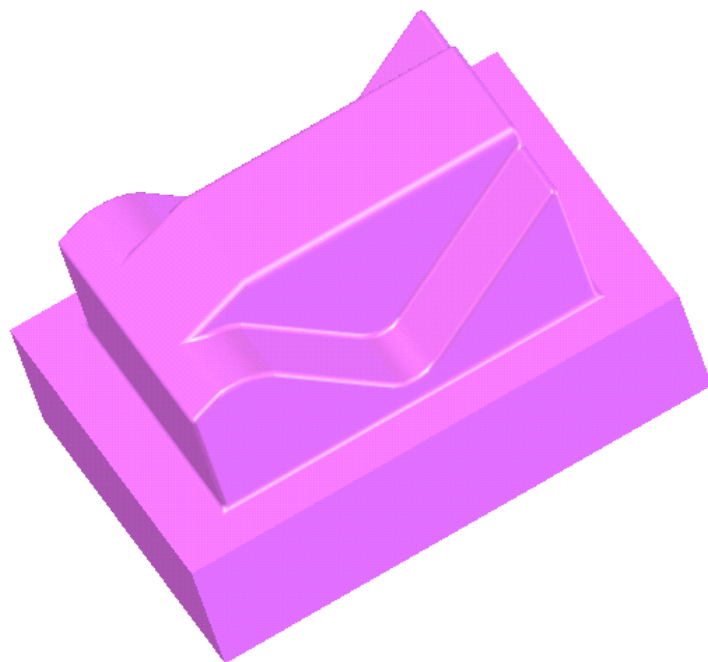

Ký hiệu (Code)
K03-01-03-02

Tên chi tiết (Name of autopart)
KHUÔN TAI MÓC HAI LỖ

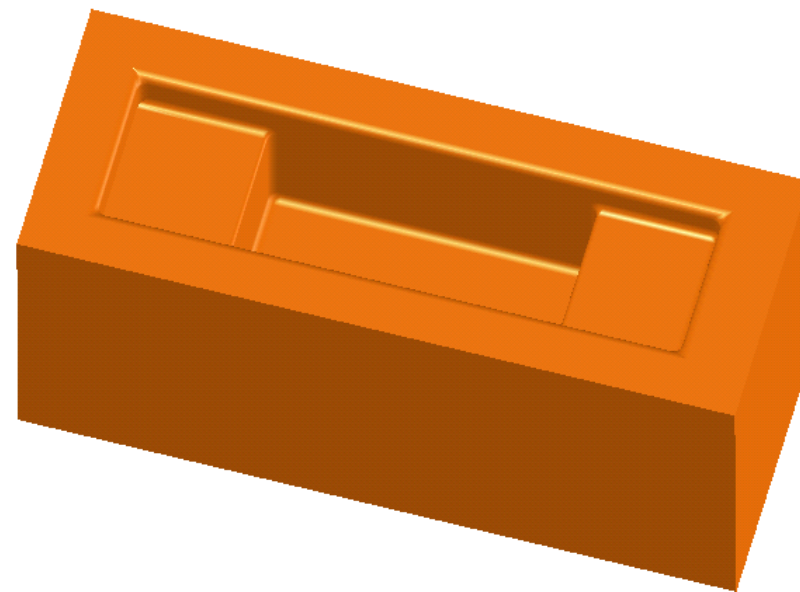
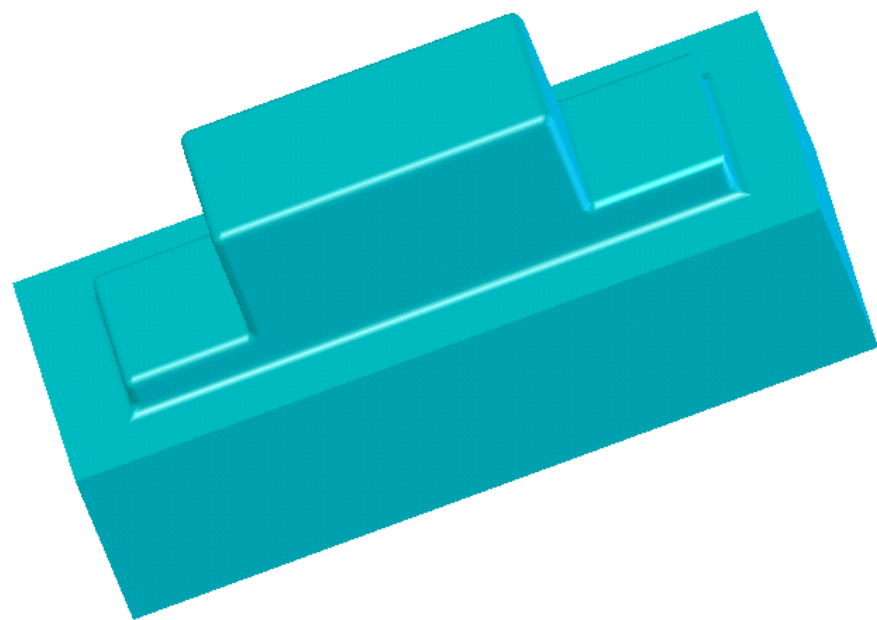

Ký hiệu (Code)
K03-01-03-03

Tên chi tiết (Name of autopart)
KHUÔN TAI MÓC MỘT LỖ DƯỚI

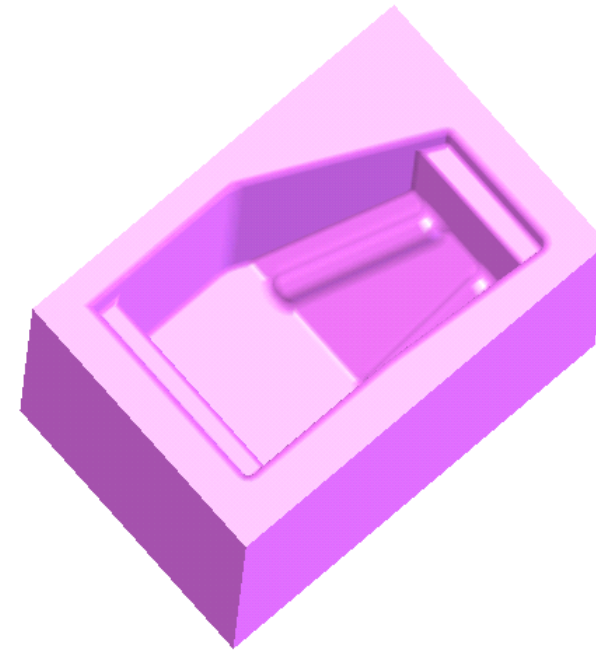
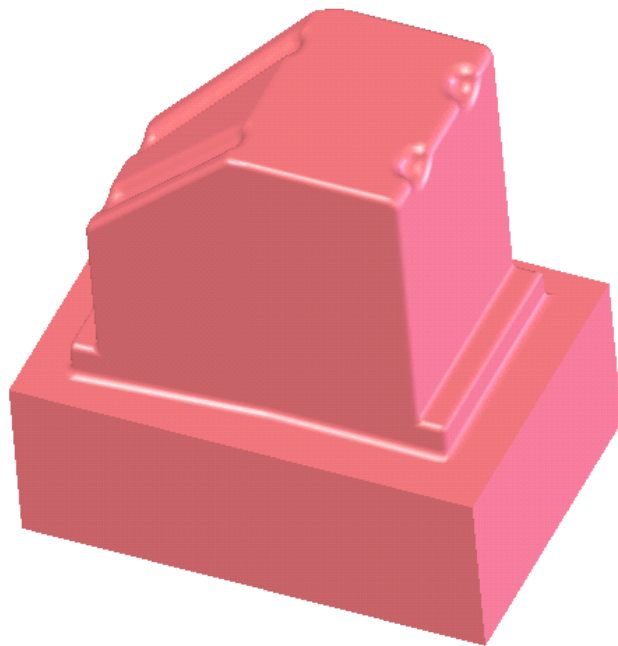

Ký hiệu (Code)
K03-01-04-00

Tên chi tiết (Name of autopart)
KHUÔN KHUNG PHẢI GIỮ

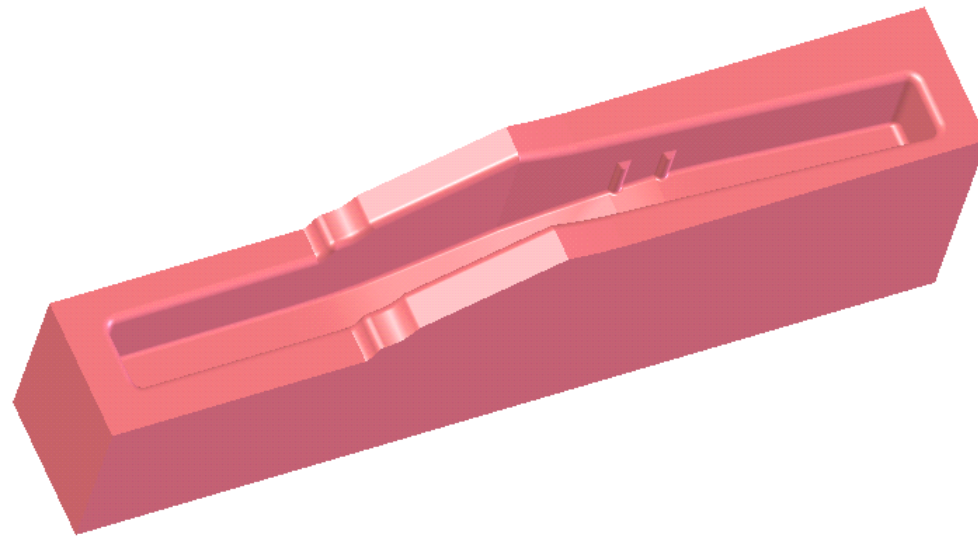
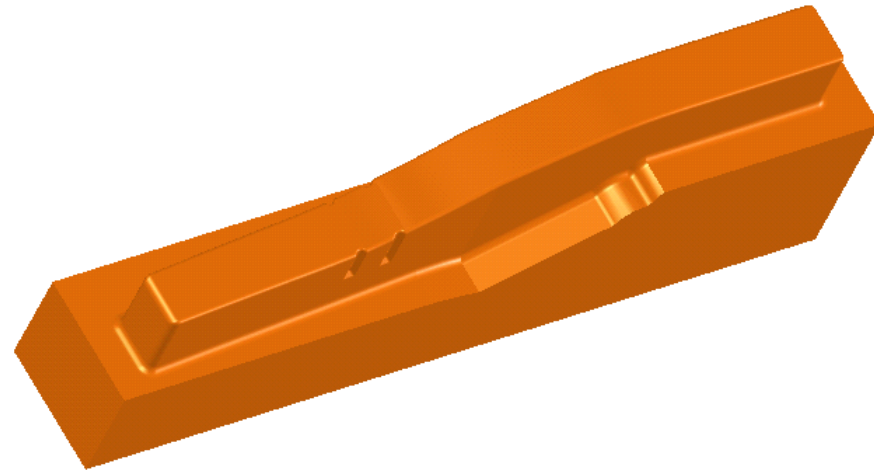

Ký hiệu (Code)
K03-01-04-01

Tên chi tiết (Name of autopart)
KHUÔN MIẾNG ĐỆM

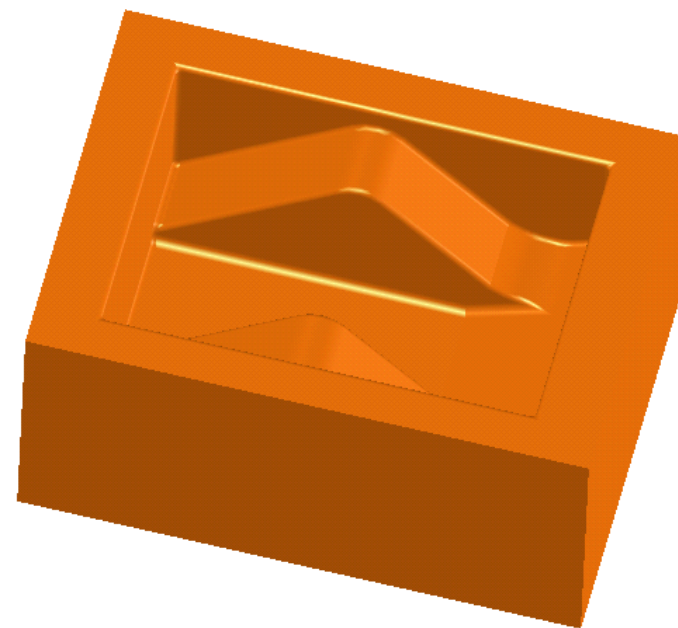
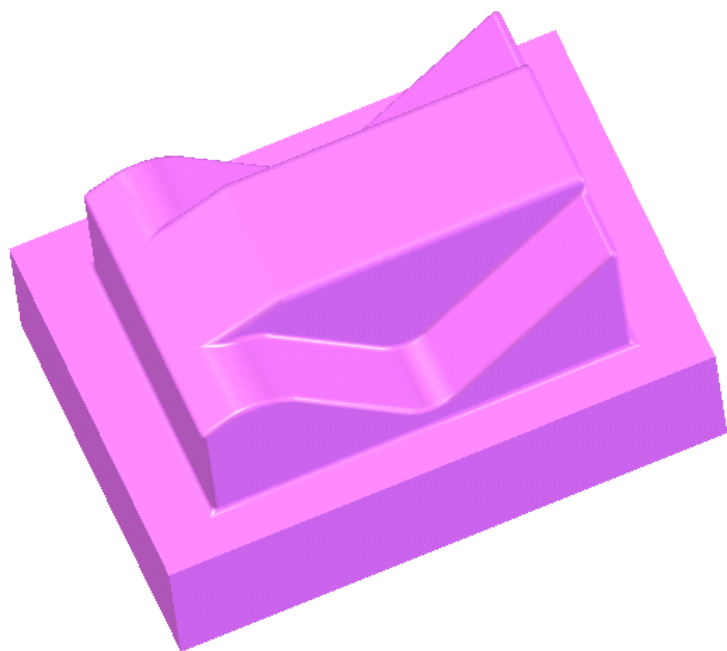

Ký hiệu (Code)
K03-01-05-00

Tên chi tiết (Name of autopart)
KHUÔN KHUNG TRÁI SAU

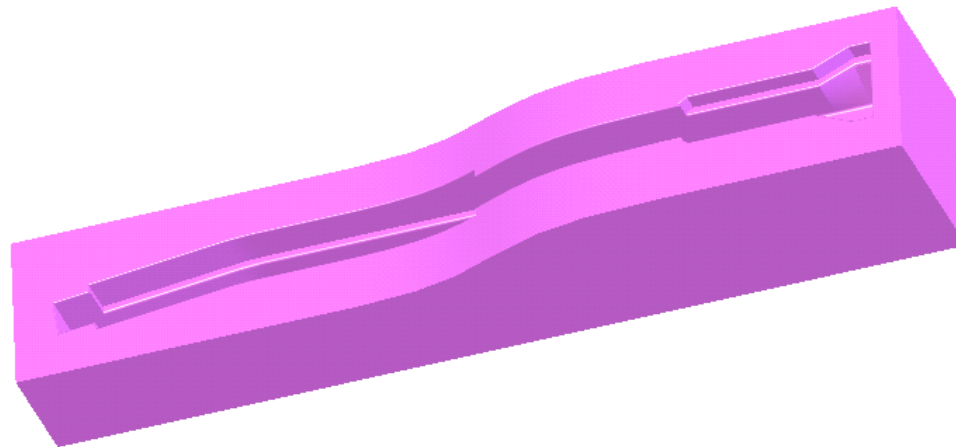
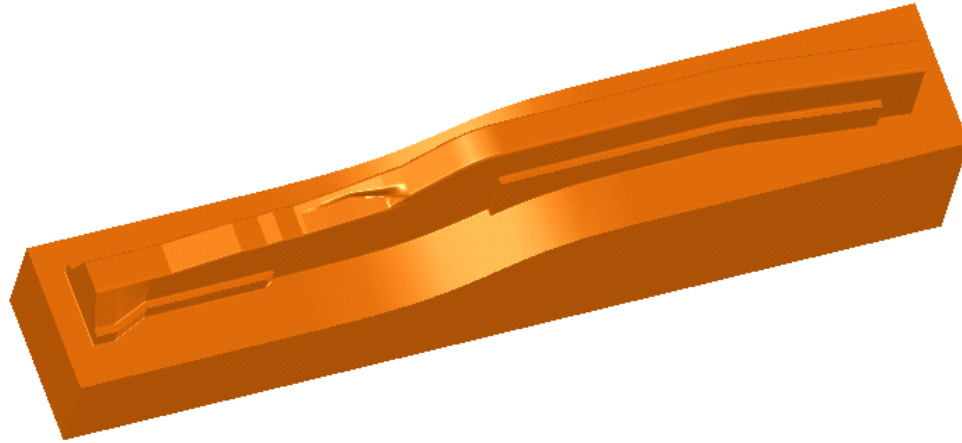

Ký hiệu (Code)
K03-01-05-01

Tên chi tiết (Name of autopart)
KHUÔN CHÂN DƯỚI

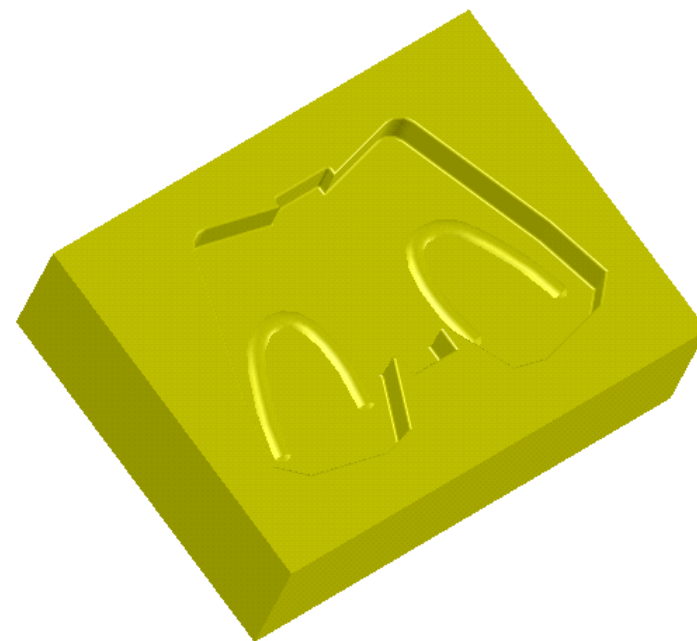
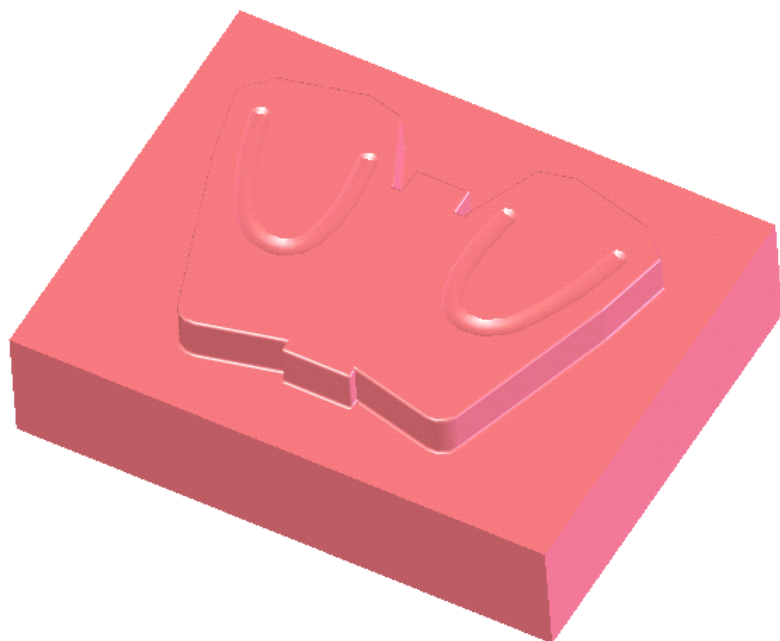

Ký hiệu (Code)
K03-01-05-01-01

Tên chi tiết (Name of autopart)
KHUÔN TẤM ỐP CHÂN DƯỚI

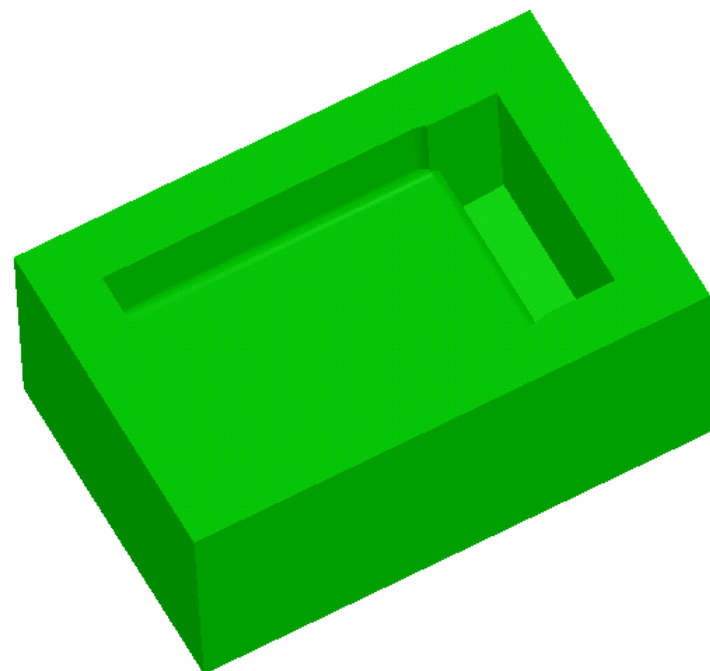
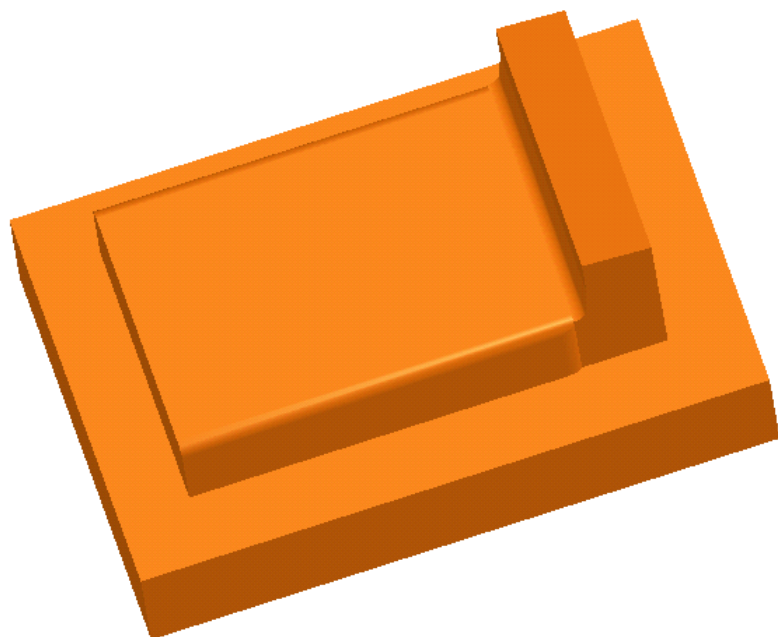

Ký hiệu (Code)
K03-01-05-02

Tên chi tiết (Name of autopart)
KHUÔN TAI MÓC DƯỚI

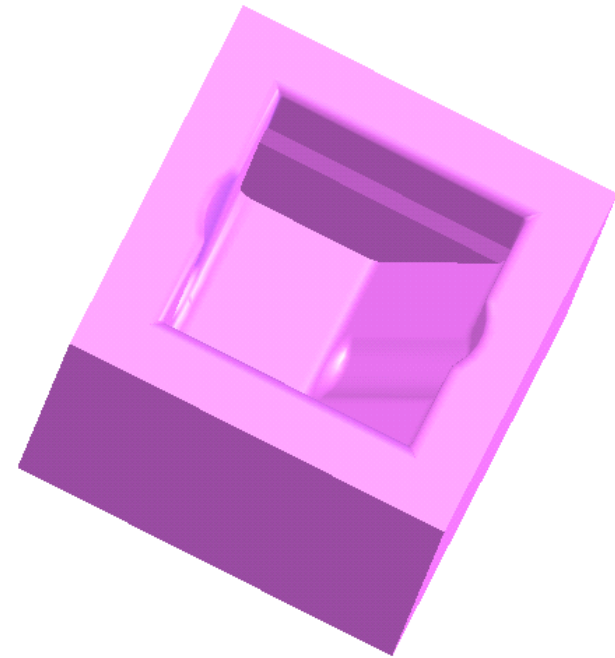
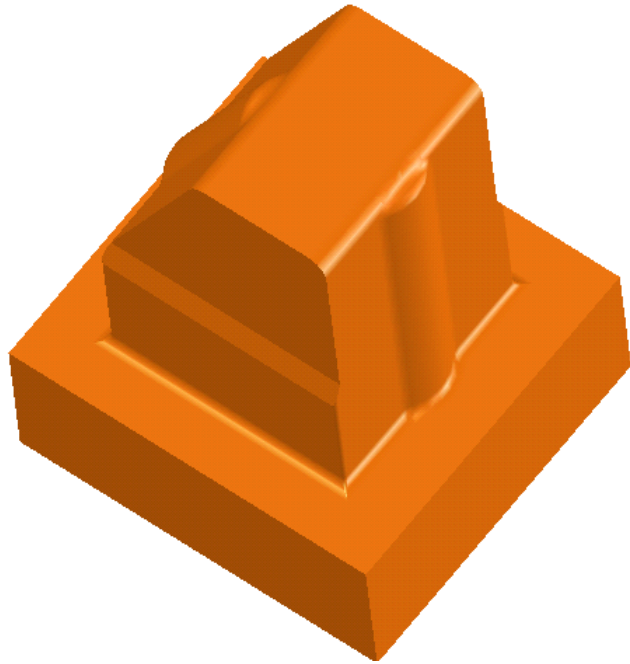

Ký hiệu (Code)
K03-01-05-03

Tên chi tiết (Name of autopart)
KHUÔN ĐỆM KHUNG

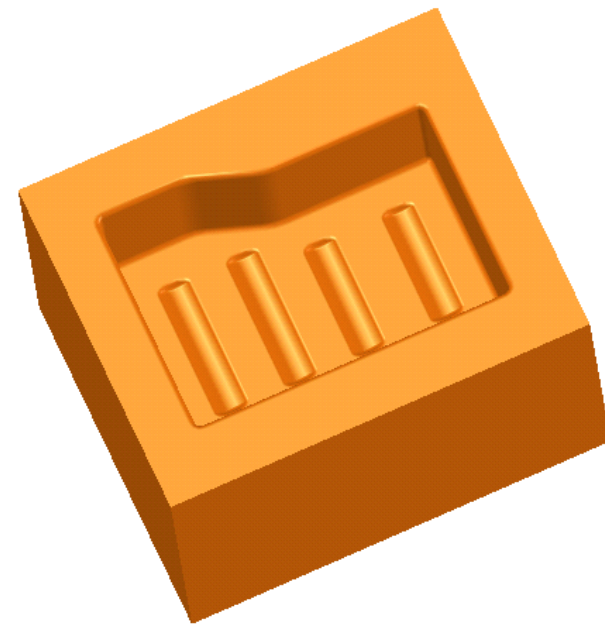
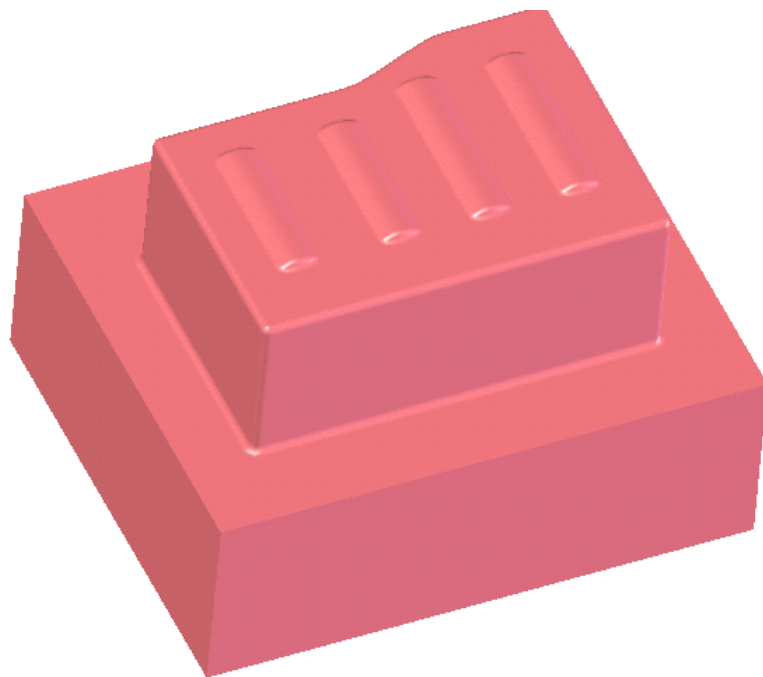

Ký hiệu (Code)
K03-01-05-04

Tên chi tiết (Name of autopart)
KHUÔN MÓC

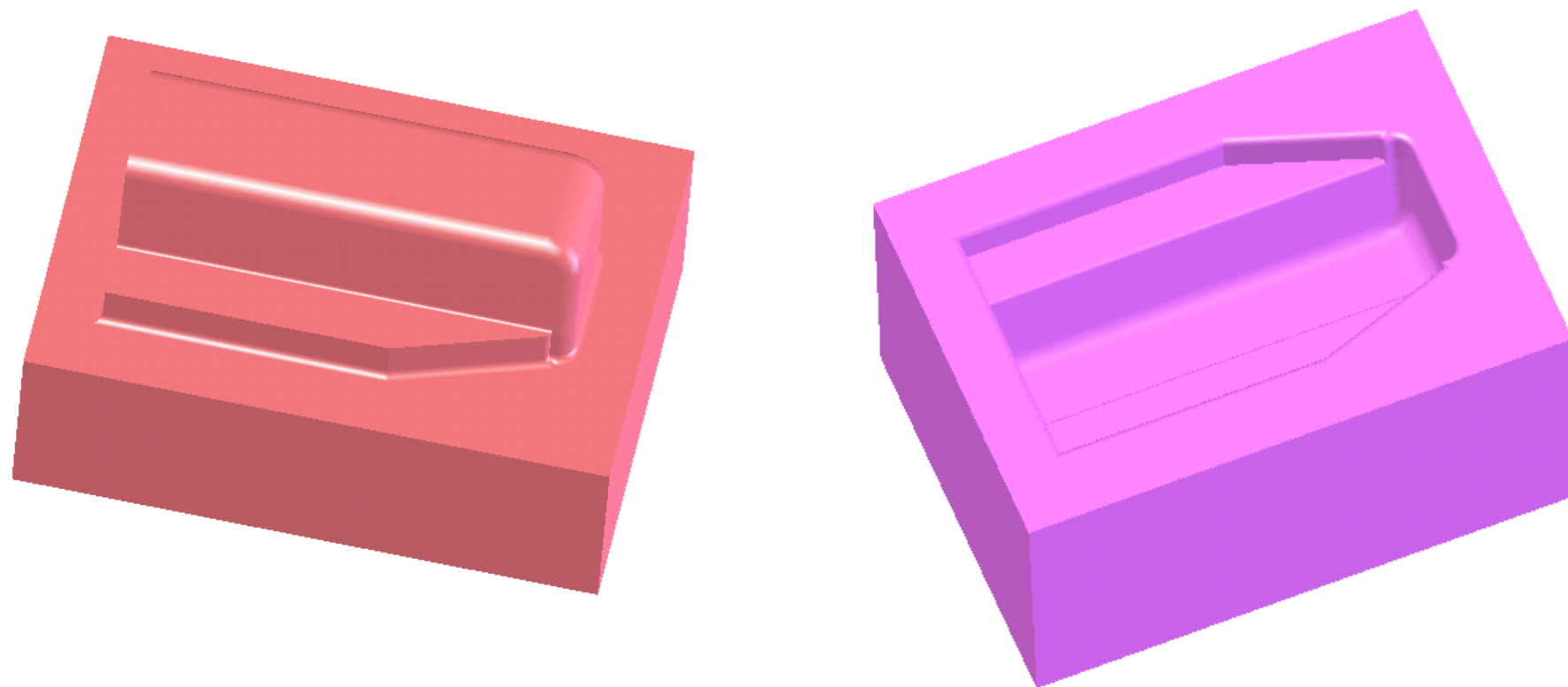

Ký hiệu (Code)
K03-01-06-00

Tên chi tiết (Name of autopart)
KHUÔN MIẾNG ĐỆM

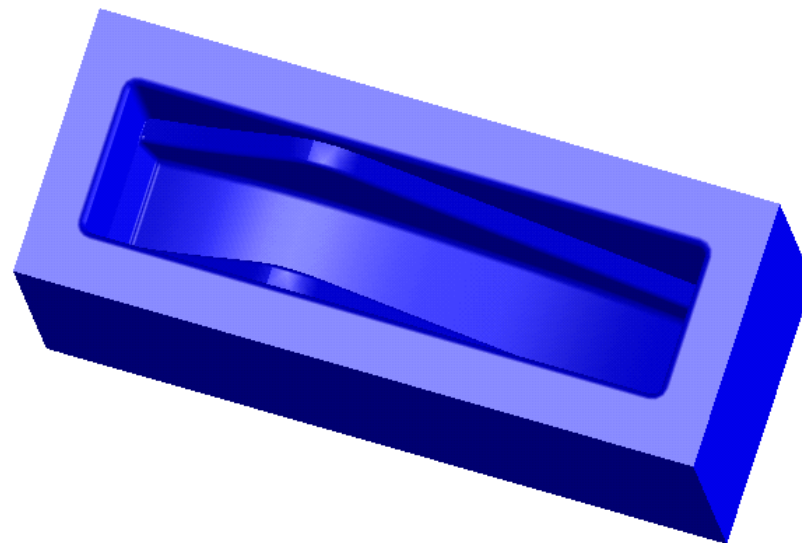
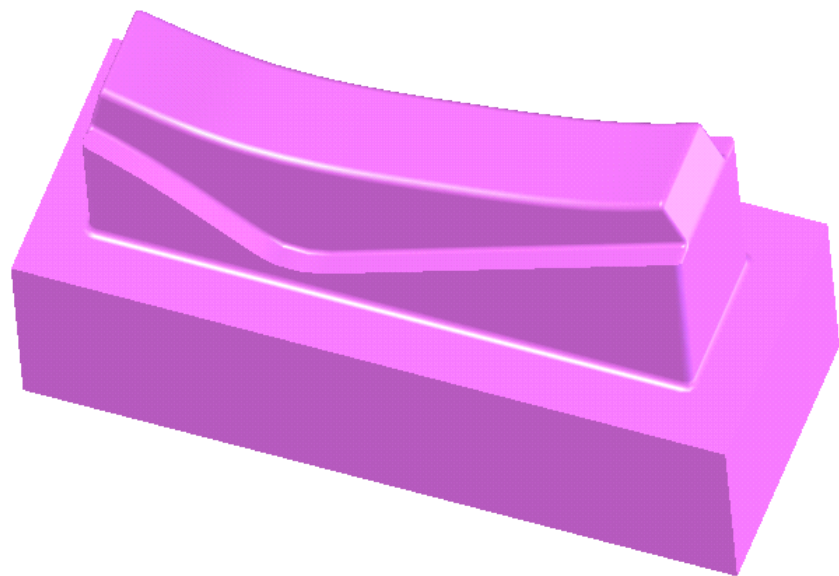

Ký hiệu (Code)
K03-01-05-07

Tên chi tiết (Name of autopart)
KHUÔN Ụ ĐỖ

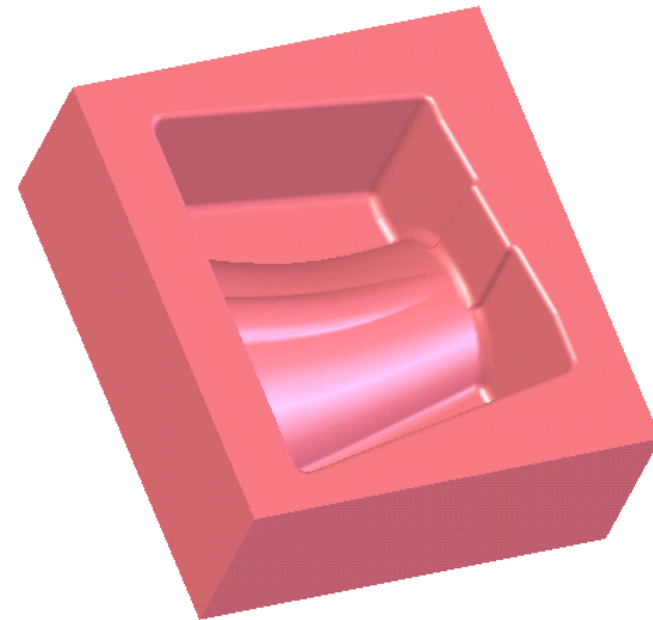
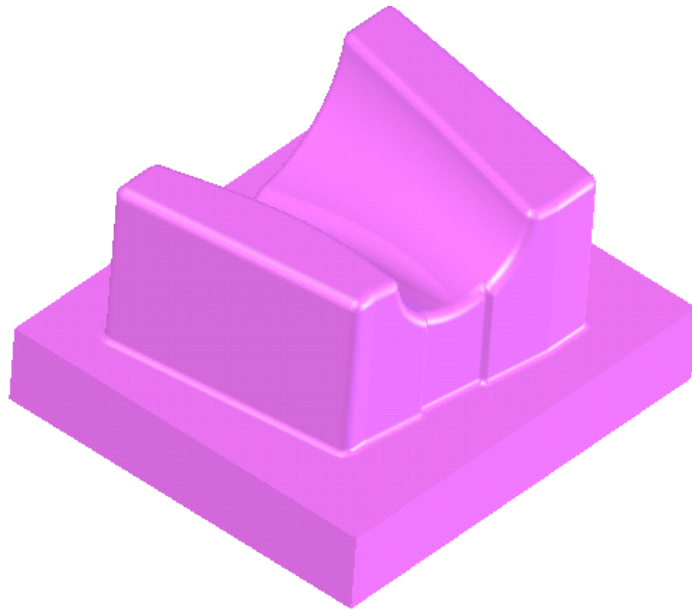

Ký hiệu (Code)
K03-01-05-07-02

Tên chi tiết (Name of autopart)
KHUÔN TAI

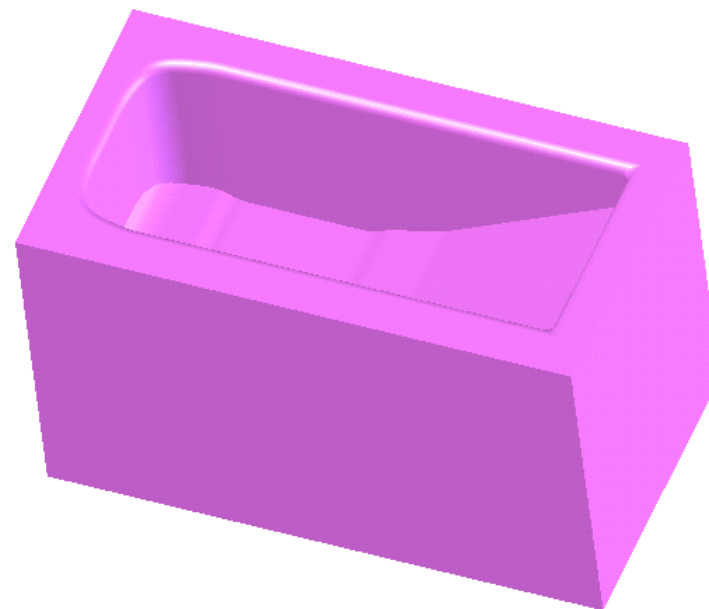
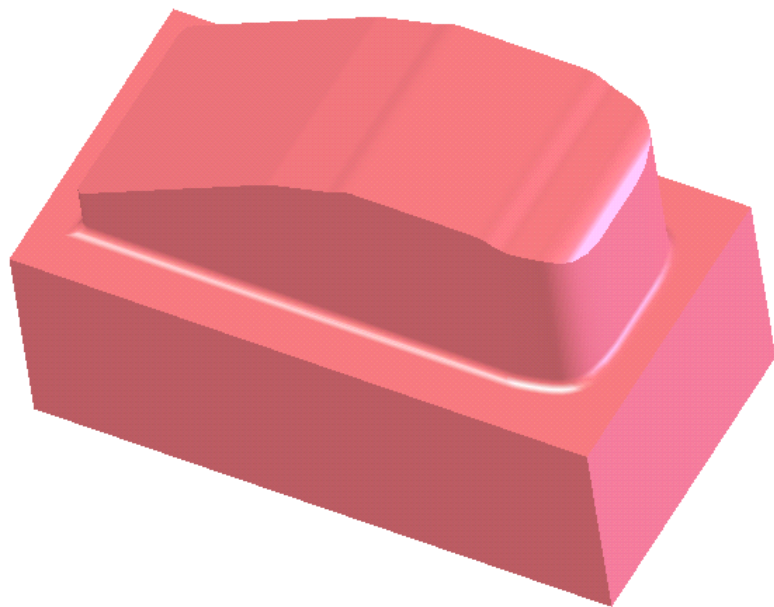

Ký hiệu (Code)
K03-01-06-00

Tên chi tiết (Name of autopart)
KHUÔN KHUNG PHẢI SAU

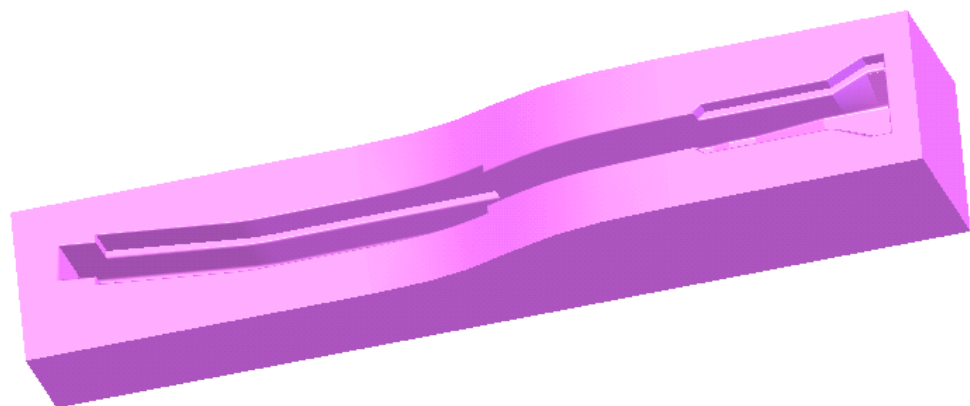
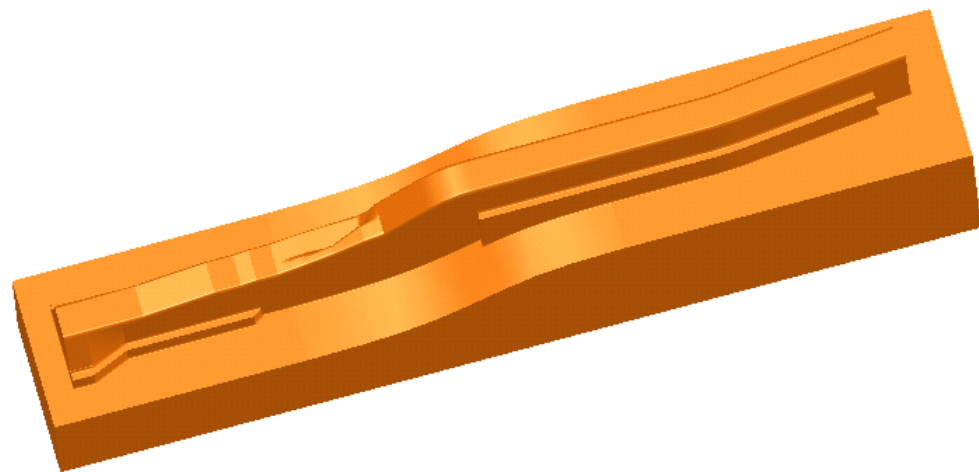

Ký hiệu (Code)
K03-01-06-07

Tên chi tiết (Name of autopart)
KHUÔN Ụ ĐỖ

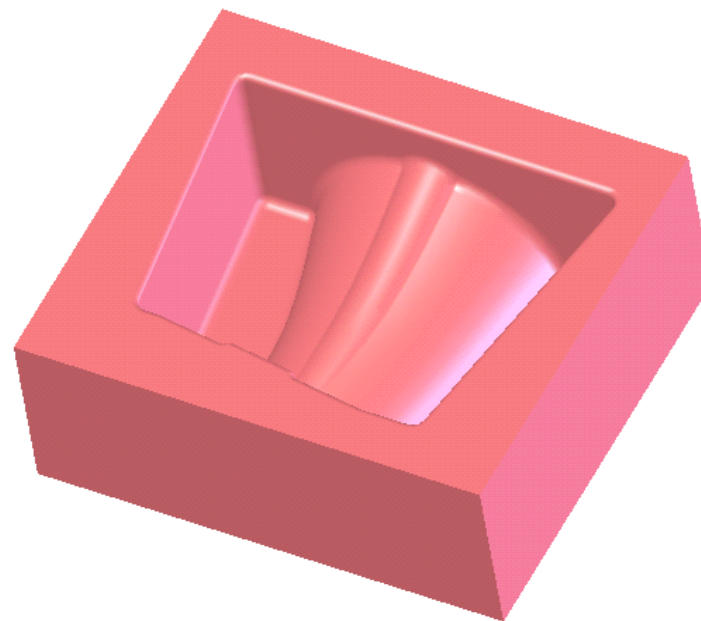
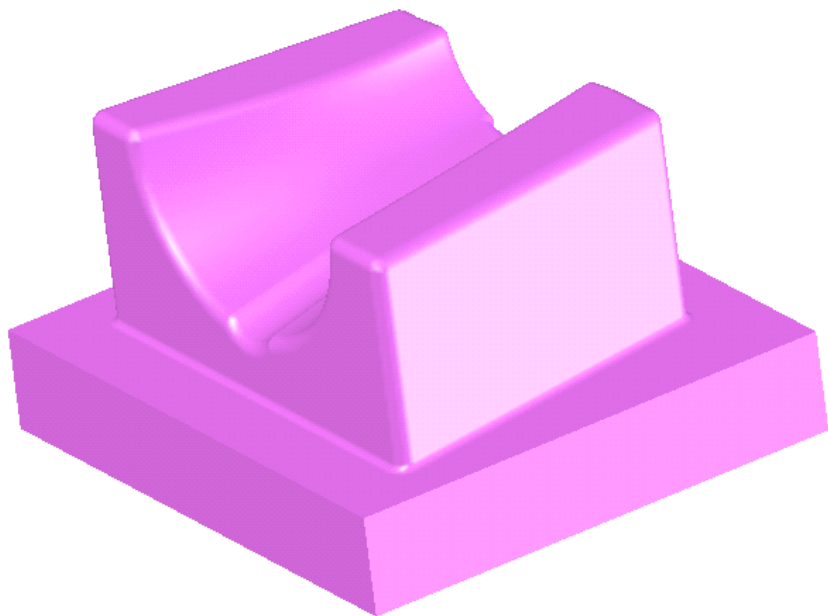

Ký hiệu (Code)
K03-01-06-09

Tên chi tiết (Name of autopart)
KHUÔN ỐP ĐỆM TRONG KHUNG PHẢI SAU

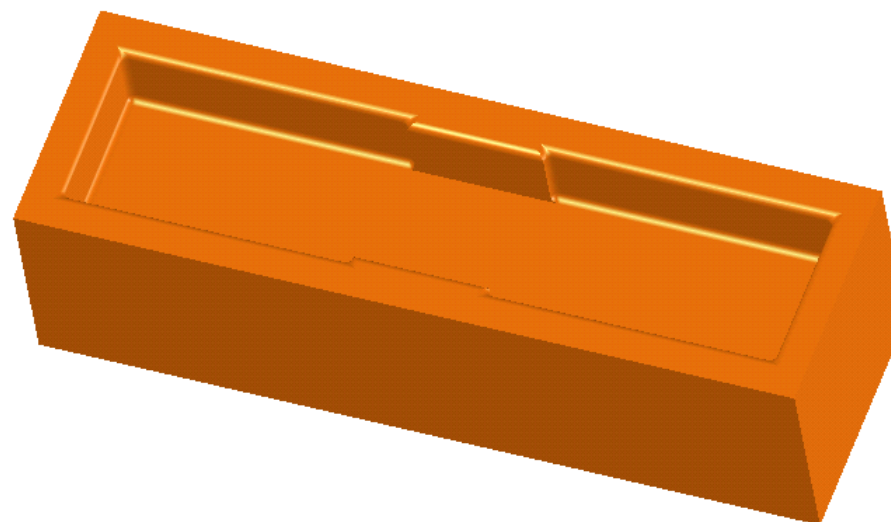
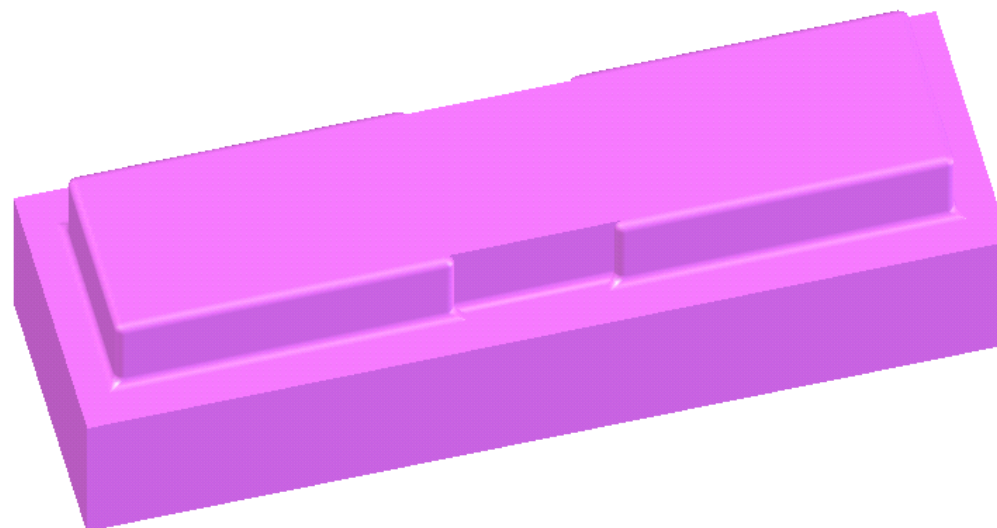

Ký hiệu (Code)
K03-01-09-01

Tên chi tiết (Name of autopart)
KHUÔN TAI MÓC ĐÔI

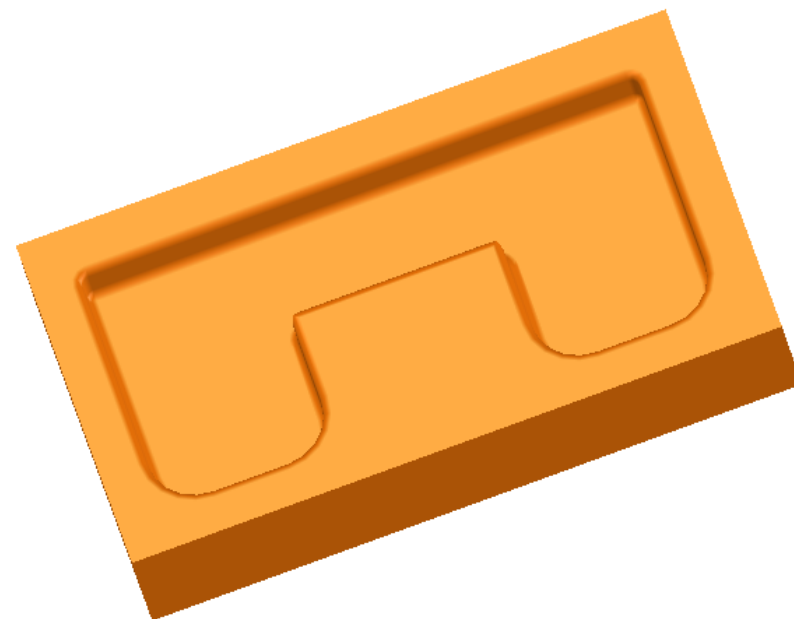
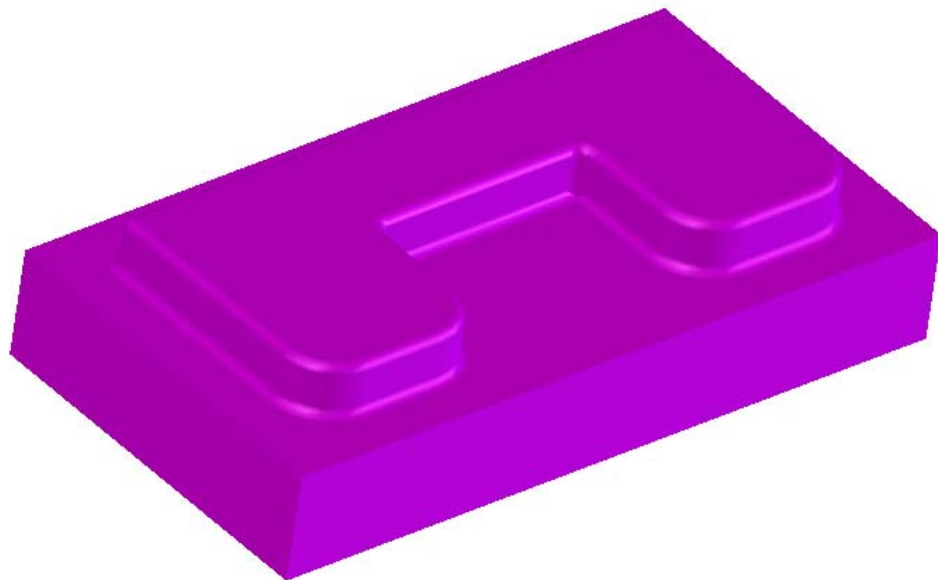

Ký hiệu (Code)
K03-01-09-02

Tên chi tiết (Name of autopart)
KHUÔN TAI MÓC

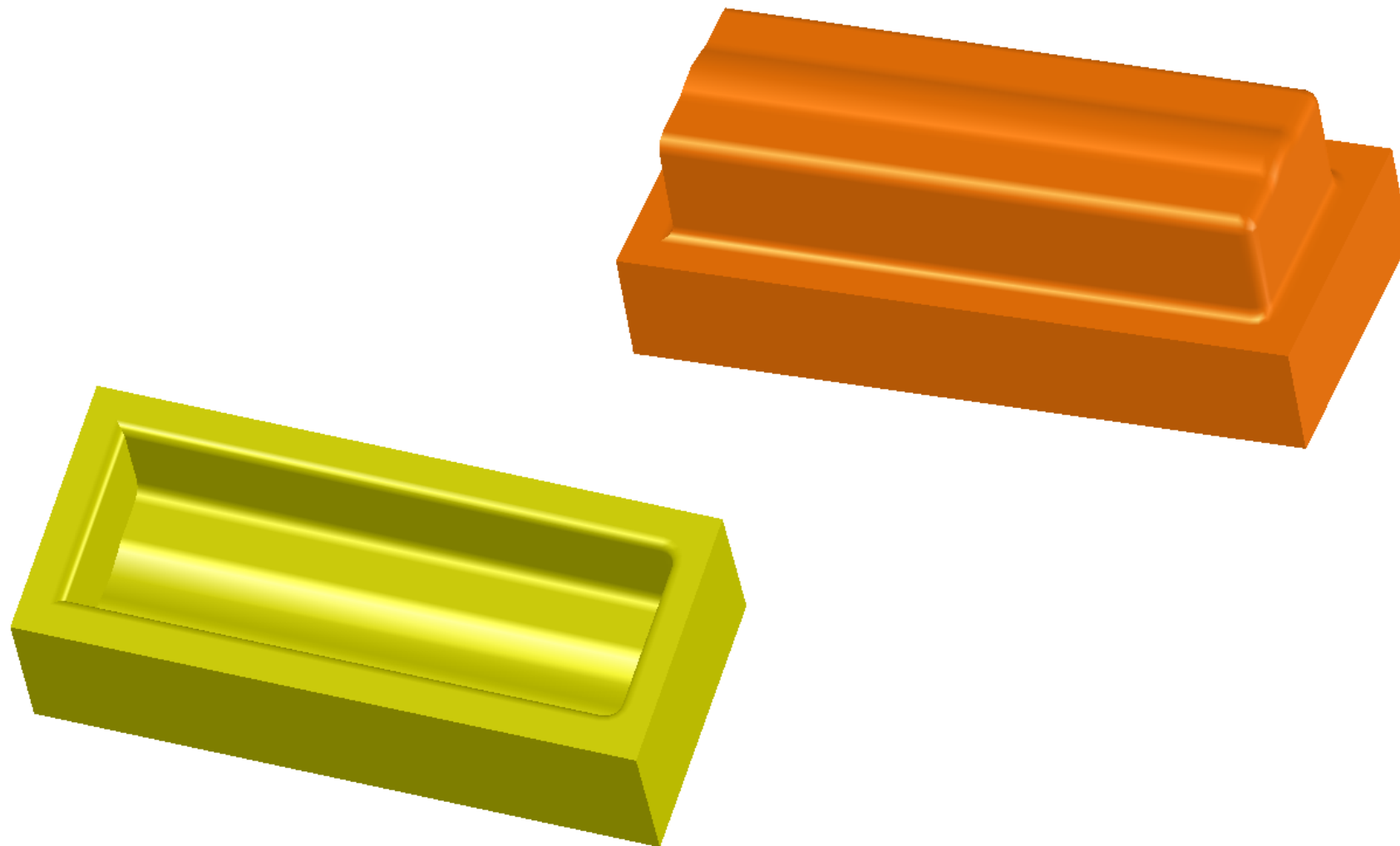

Ký hiệu (Code)
K03-01-10-00

Tên chi tiết (Name of autopart)
KHUÔN THANH VUÔNG TRƯỚC

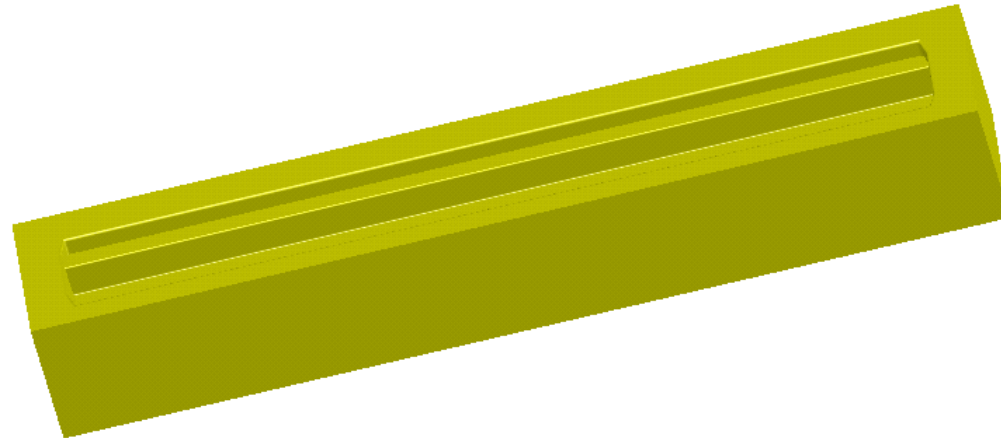
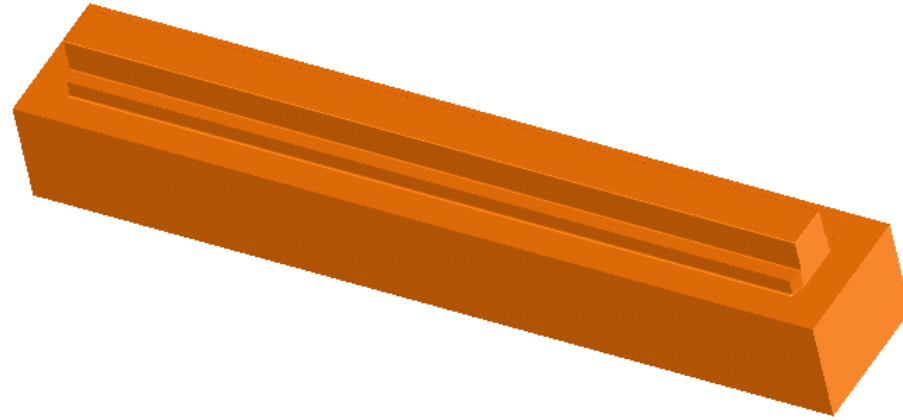

Ký hiệu (Code)
K03-01-10-01

Tên chi tiết (Name of autopart)
KHUÔN TẤM NỔI

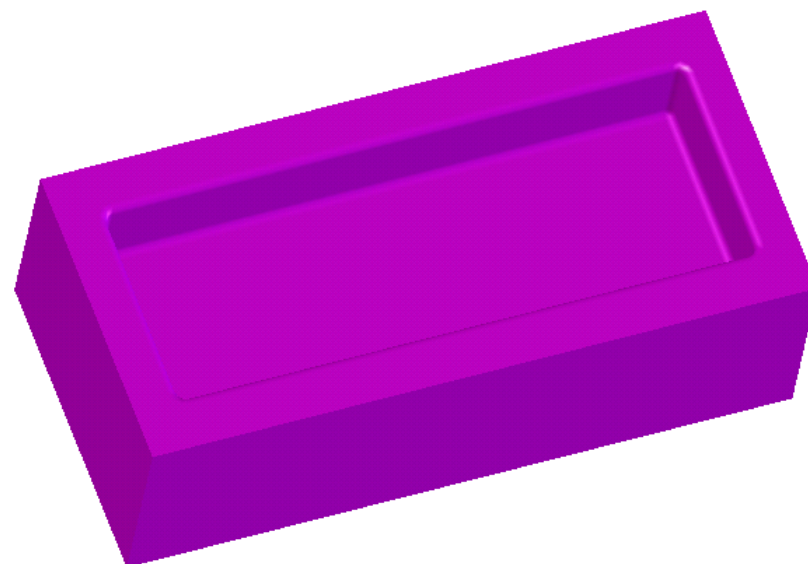

Ký hiệu (Code)
K03-01-10-03

Tên chi tiết (Name of autopart)
KHUÔN MÓC DƯỚI GIỮ BÁNH XE DỰ PHÒNG

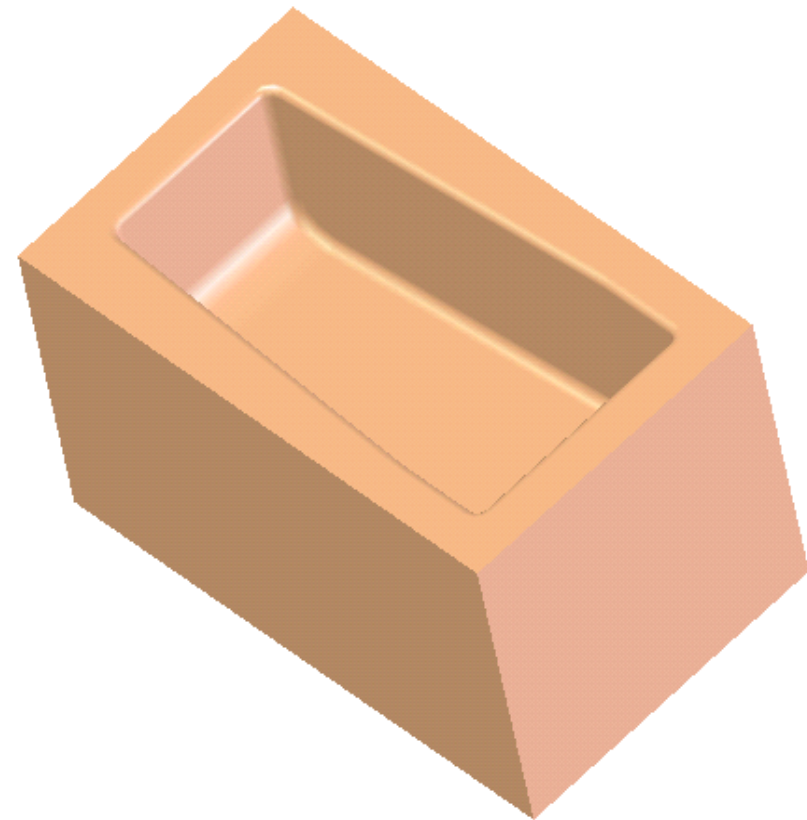
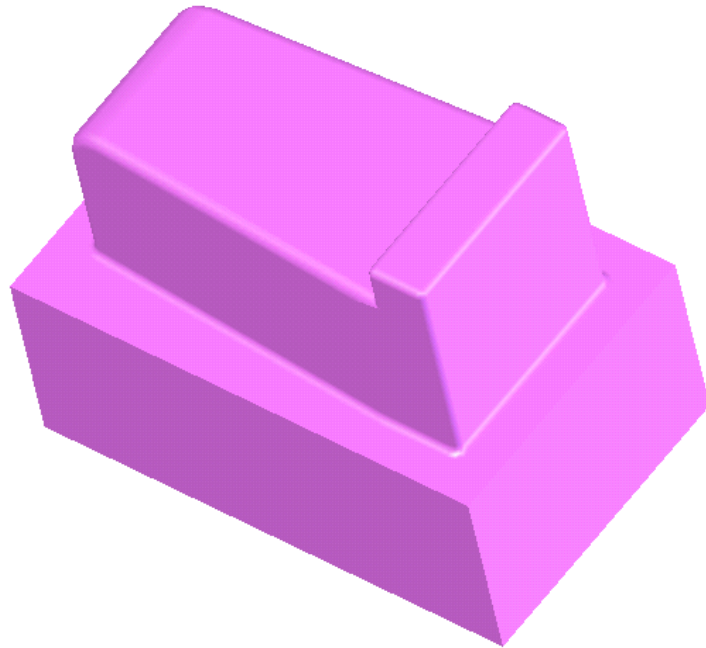

Ký hiệu (Code)
K03-01-11-00

Tên chi tiết (Name of autopart)
KHUÔN THANH VUÔNG SAU

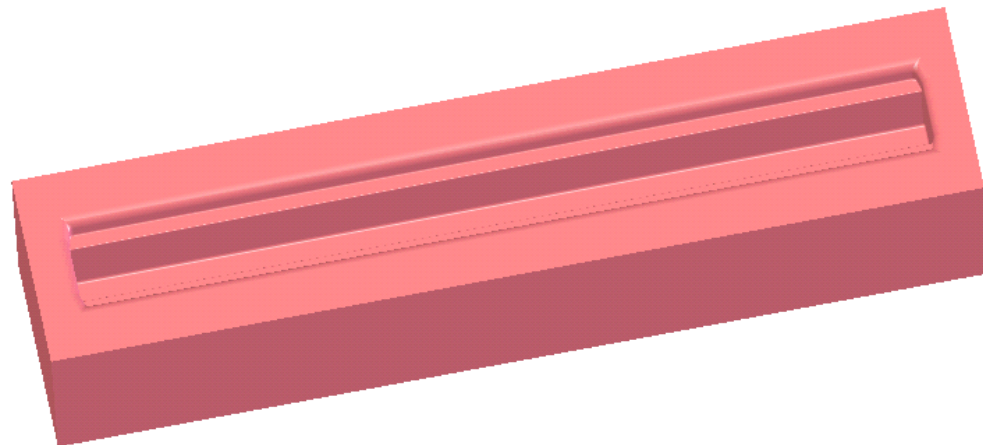
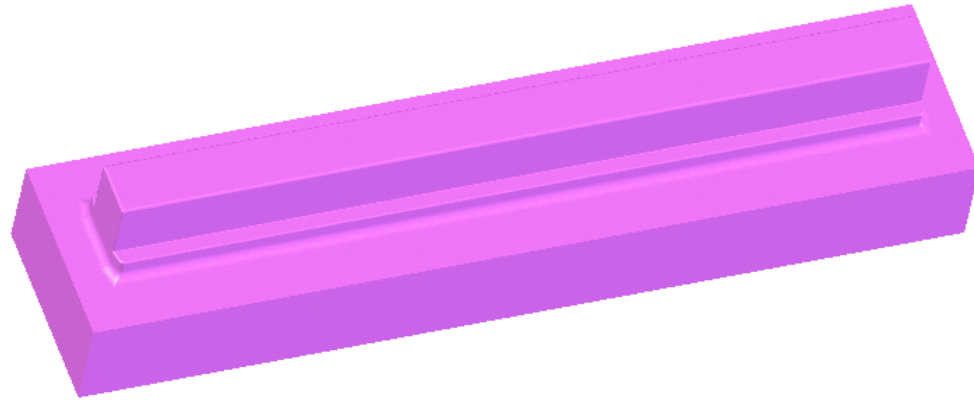

Ký hiệu (Code)
K03-01-11-01

Tên chi tiết (Name of autopart)
KHUÔN GIÁ CỐ ĐỊNH DƯỚI - NỬA SAU

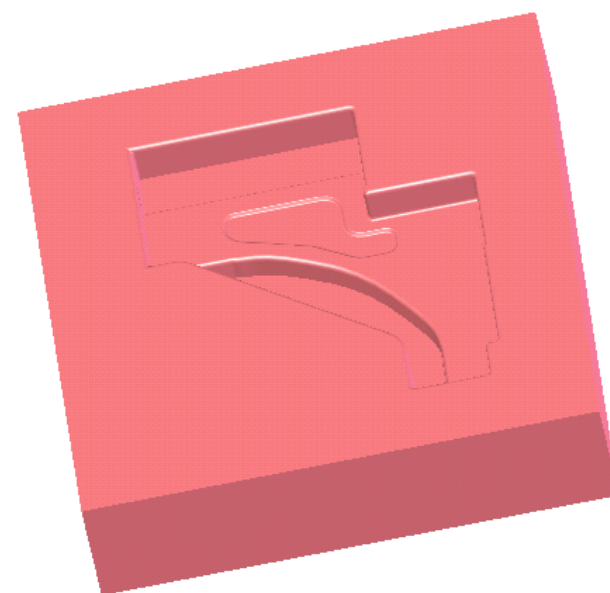
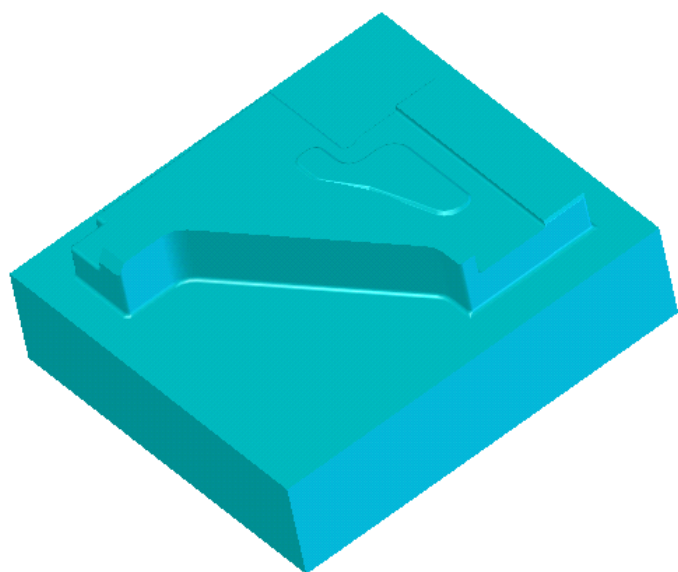

Ký hiệu (Code)
K03-01-11-02

Tên chi tiết (Name of autopart)
KHUÔN GIÁ CỐ ĐỊNH DƯỚI - NỬA TRƯỚC

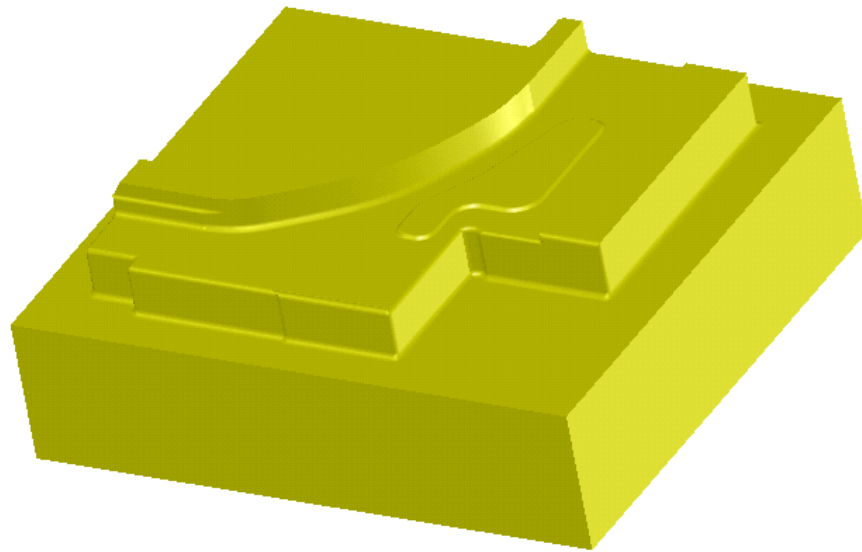

Ký hiệu (Code)
K03-01-11-03

Tên chi tiết (Name of autopart)
KHUÔN TẤM NỐI

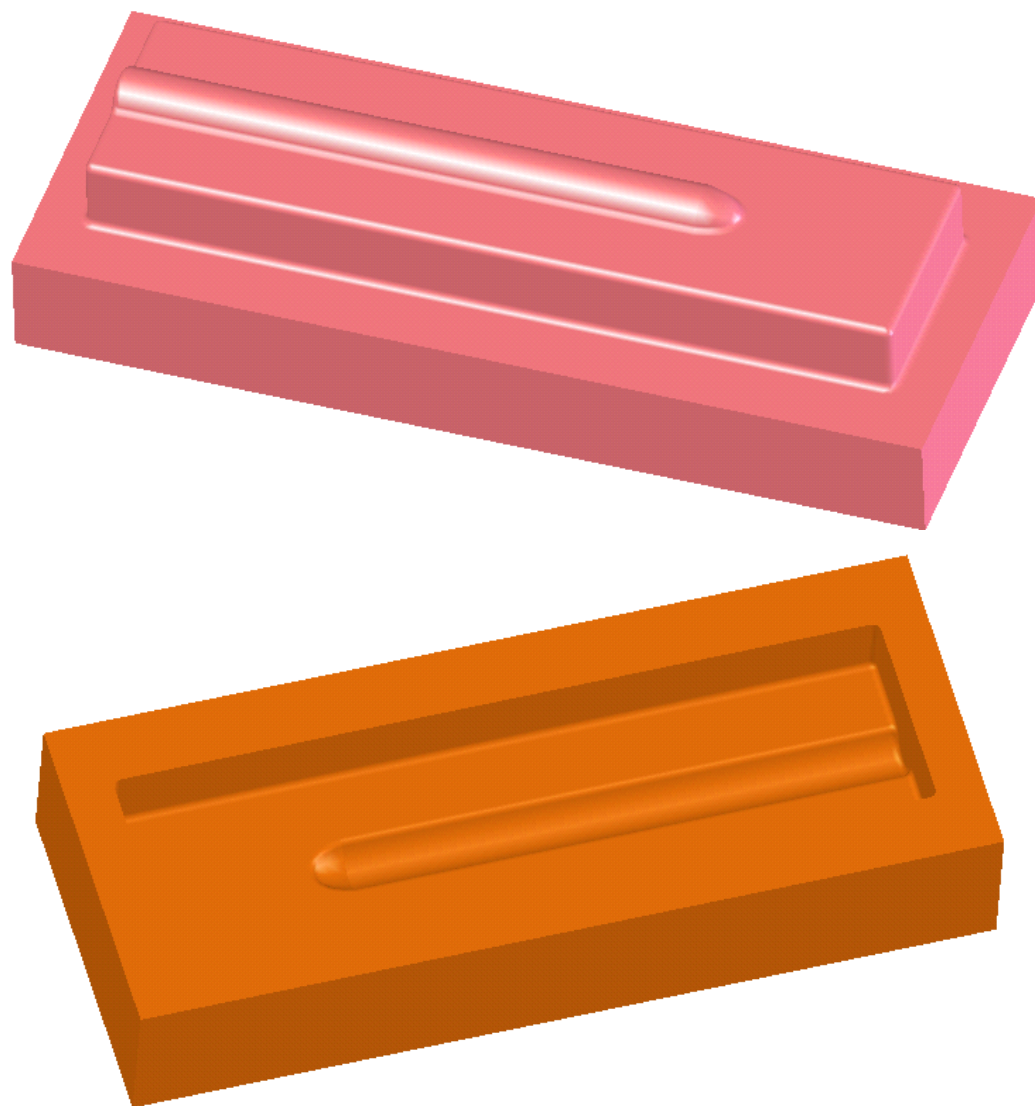

Ký hiệu (Code)
K03-01-11-05-01

Tên chi tiết (Name of autopart)
KHUÔN ỐP MÓC

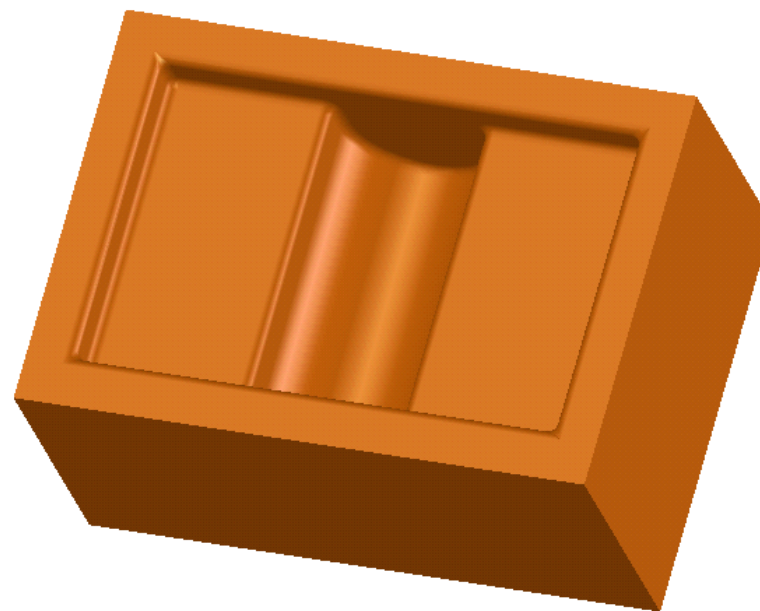
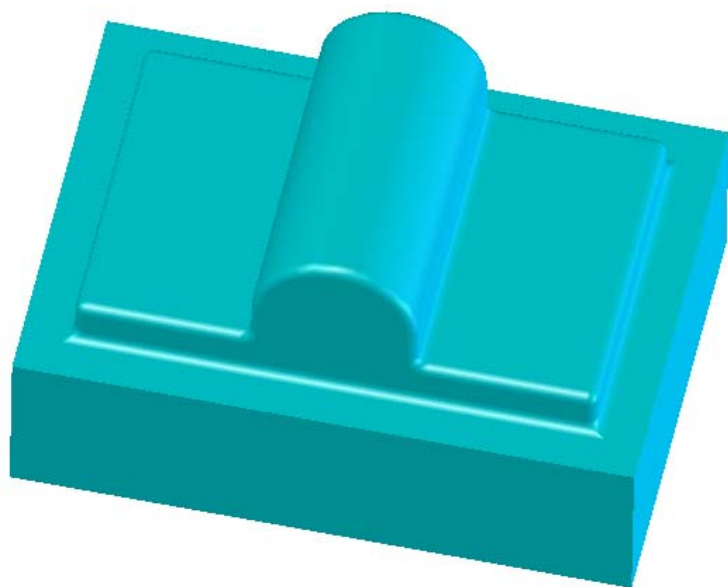

Ký hiệu (Code)
K03-01-11-06

Tên chi tiết (Name of autopart)
KHUÔN TAI MÓC

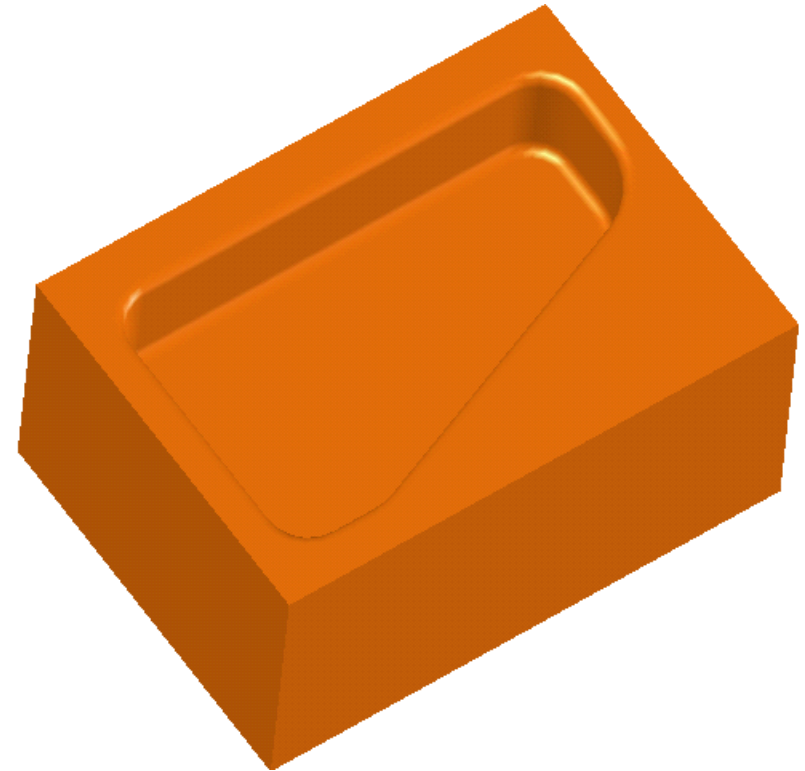
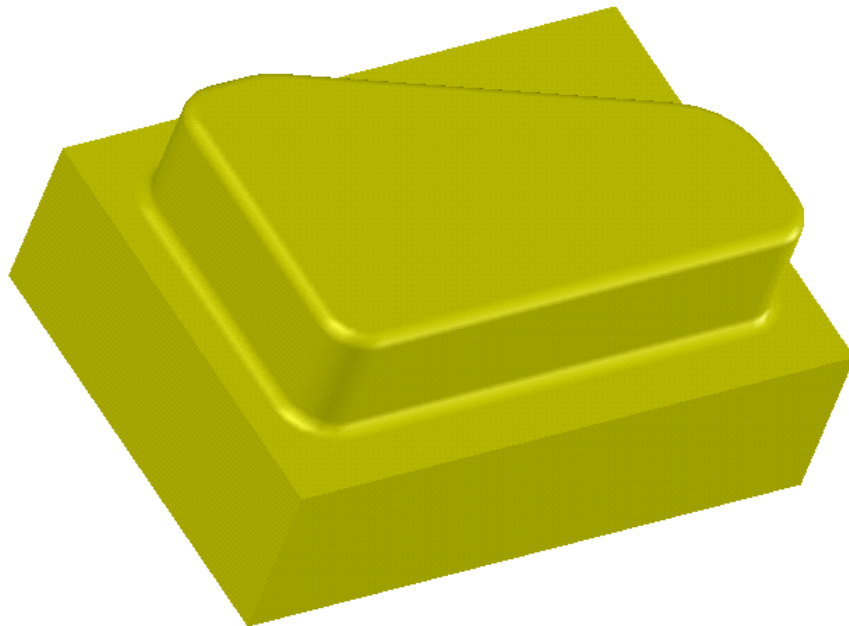

Ký hiệu (Code)
K03-01-12-01

Tên chi tiết (Name of autopart)
KHUÔN MÓC BÁNH XE DỰ PHÒNG

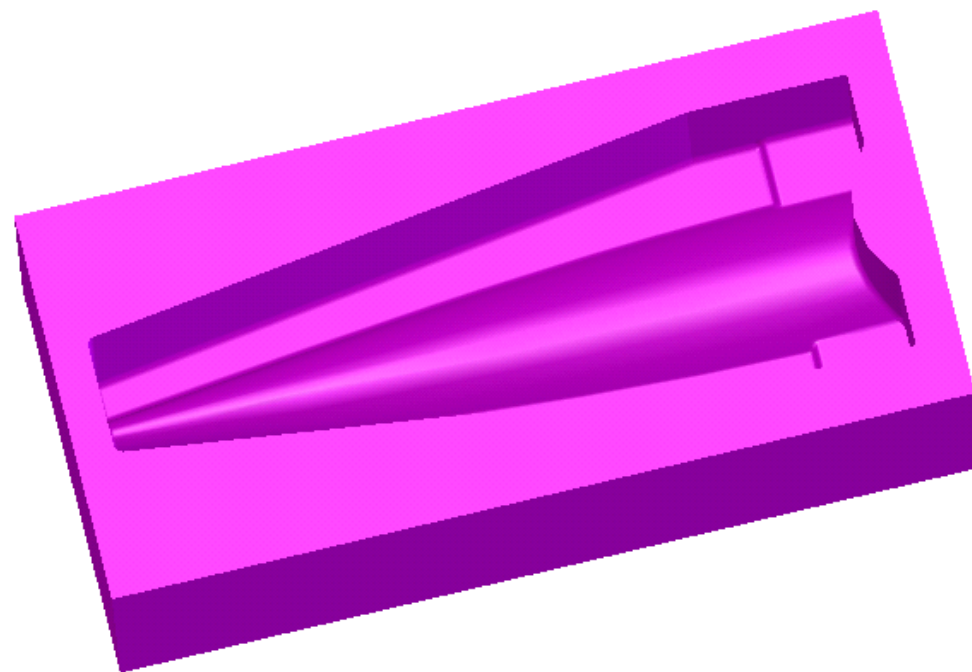
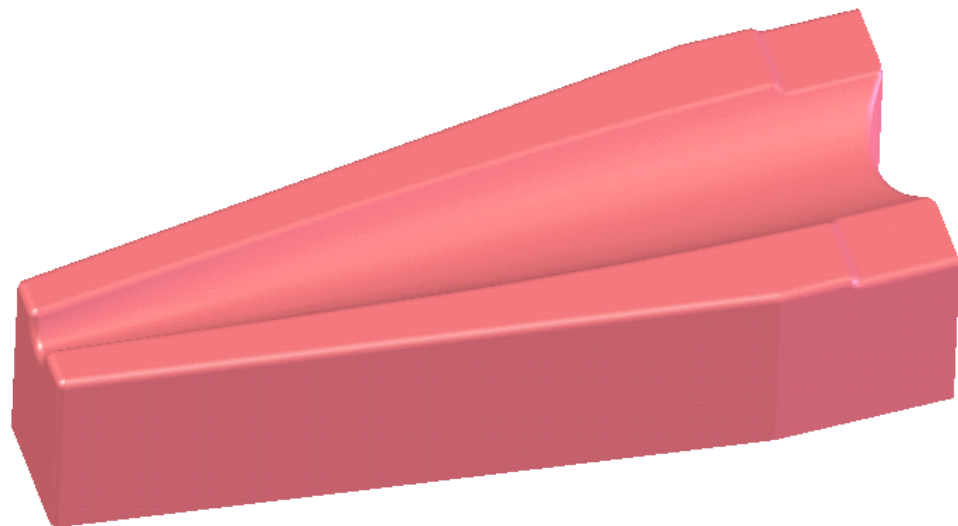

Ký hiệu (Code)
K03-01-12-02

Tên chi tiết (Name of autopart)
KHUÔN TẤM ĐỆM PHẢI

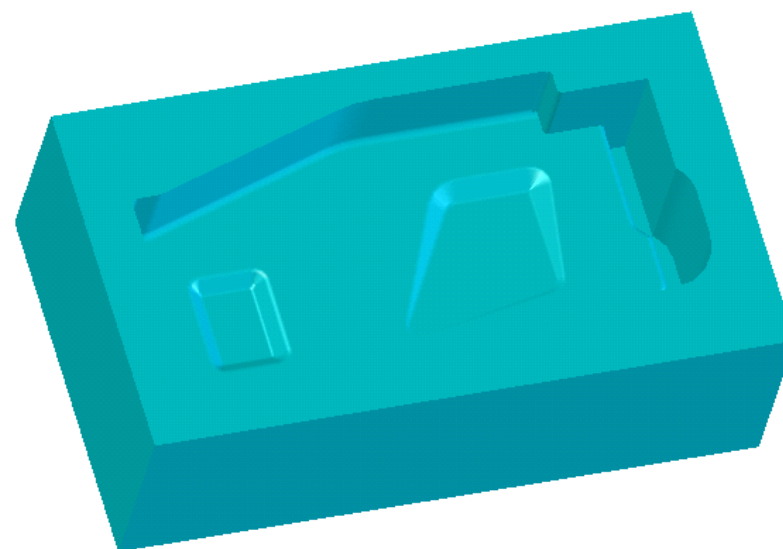
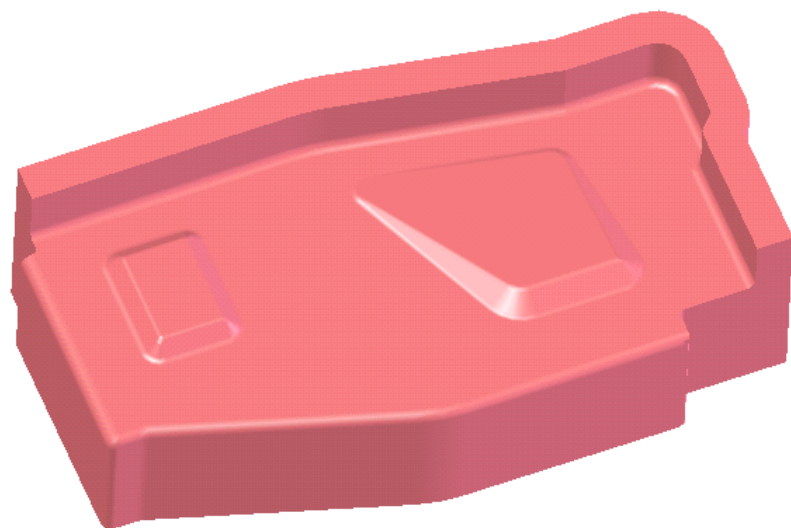

Ký hiệu (Code)
K03-02-01-01

Tên chi tiết (Name of autopart)
KHUÔN TẤM ỐP TĂNG CỨNG DƯỚI TRÁI

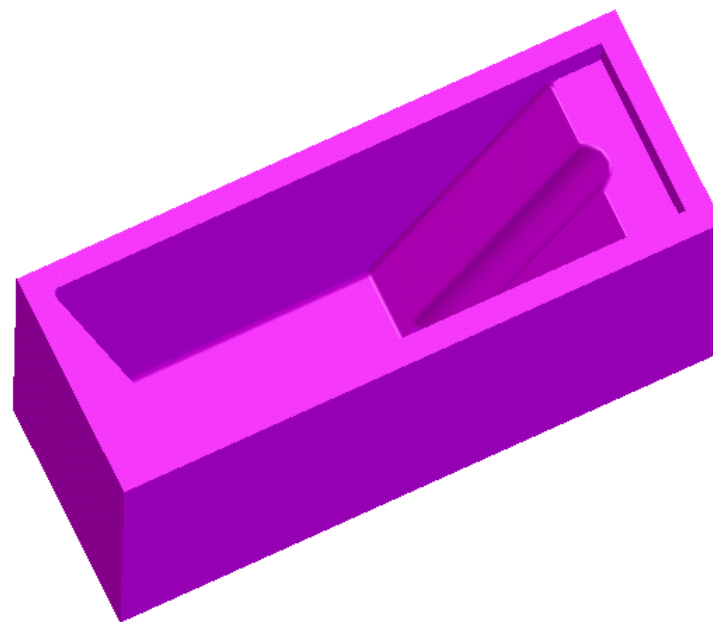
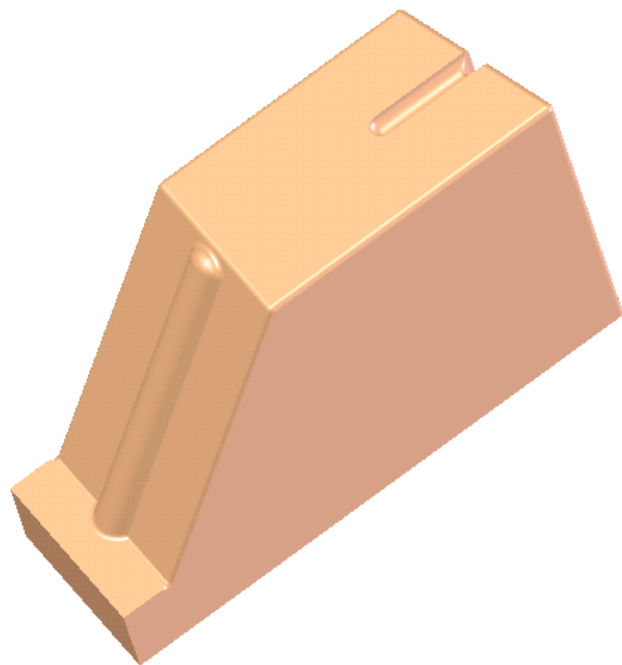

Ký hiệu (Code)
K03-02-01-03

Tên chi tiết (Name of autopart)
KHUÔN TAI MÓC

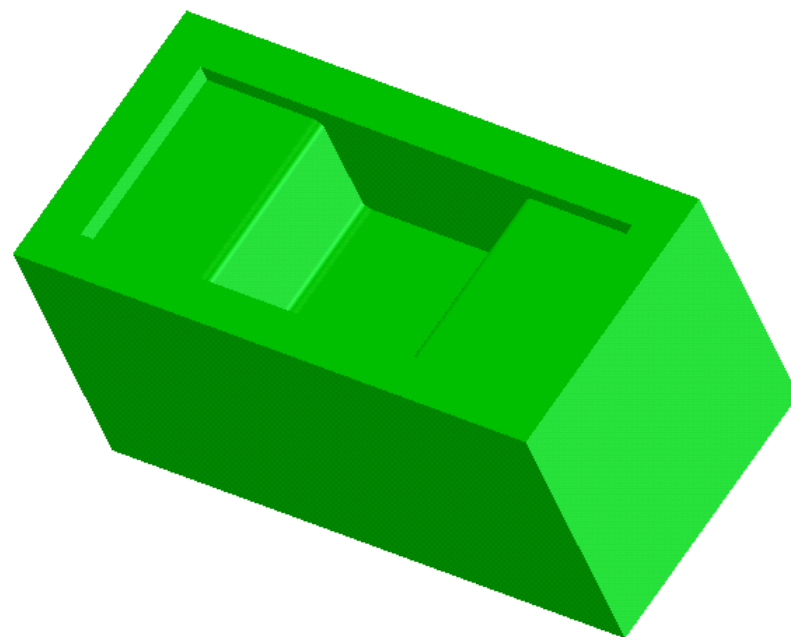
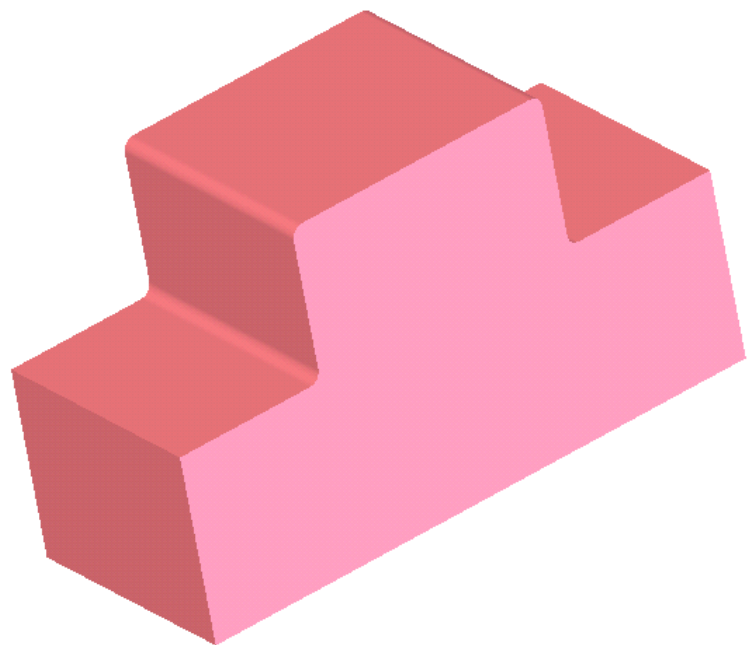

Ký hiệu (Code)
K03-02-02-00

Tên chi tiết (Name of autopart)
KHUÔN TẤM TRƯỚC BUỒNG ĐỘNG CƠ

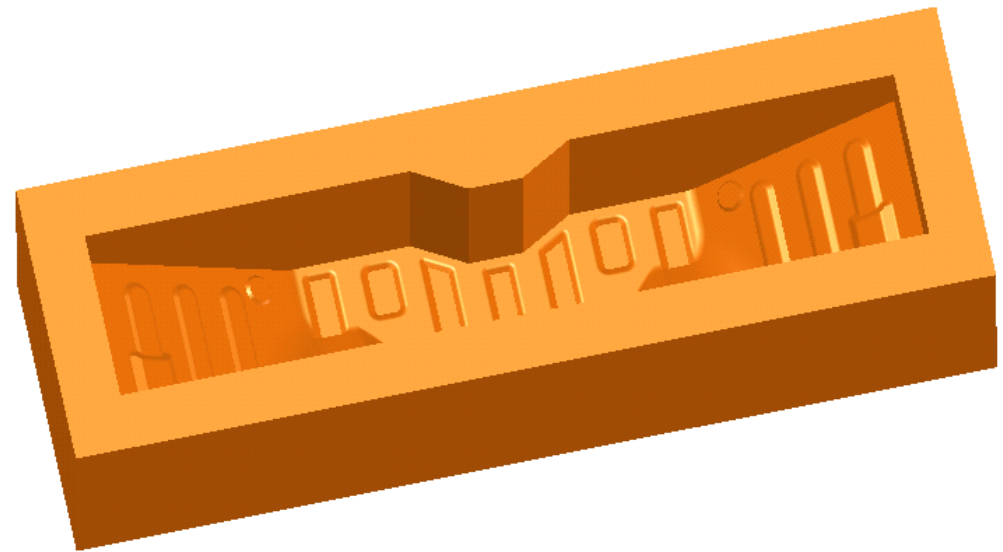
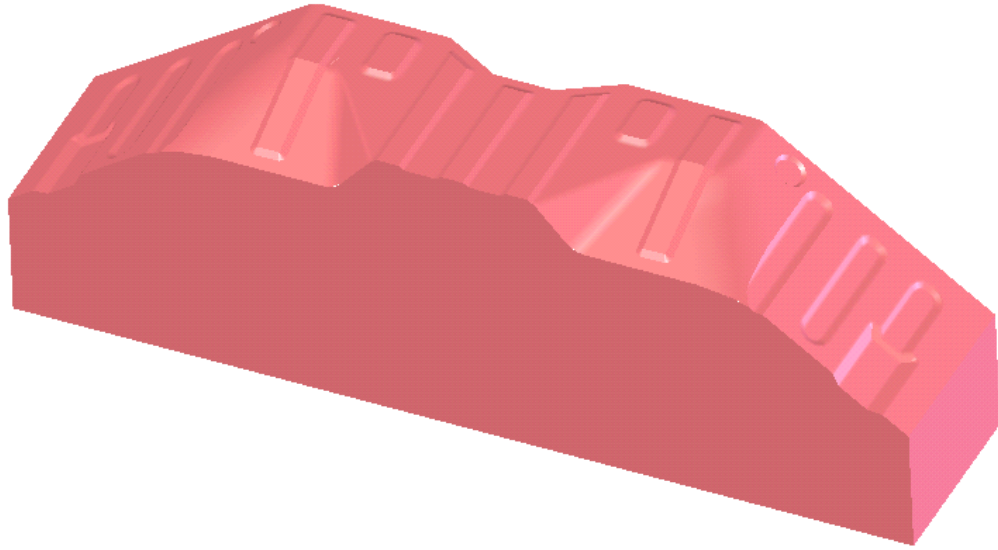

Ký hiệu (Code)
K03-02-02-03

Tên chi tiết (Name of autopart)
KHUÔN TAI GÀI DÂY

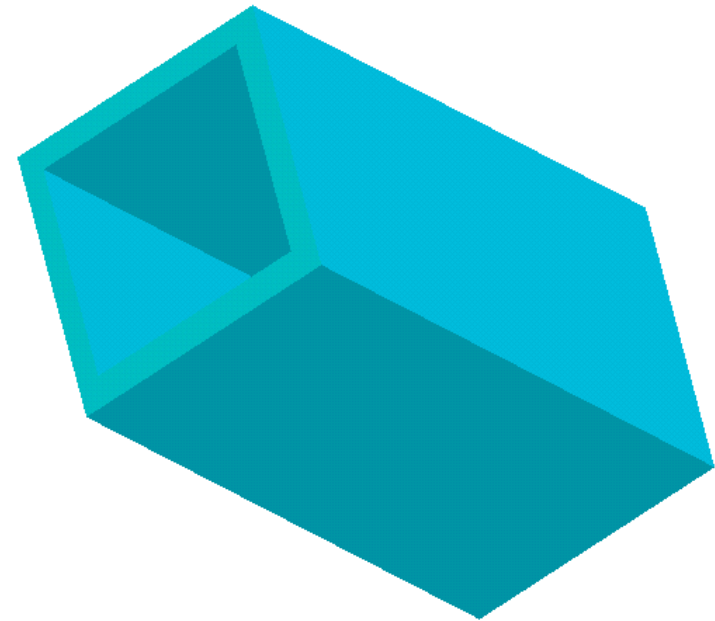
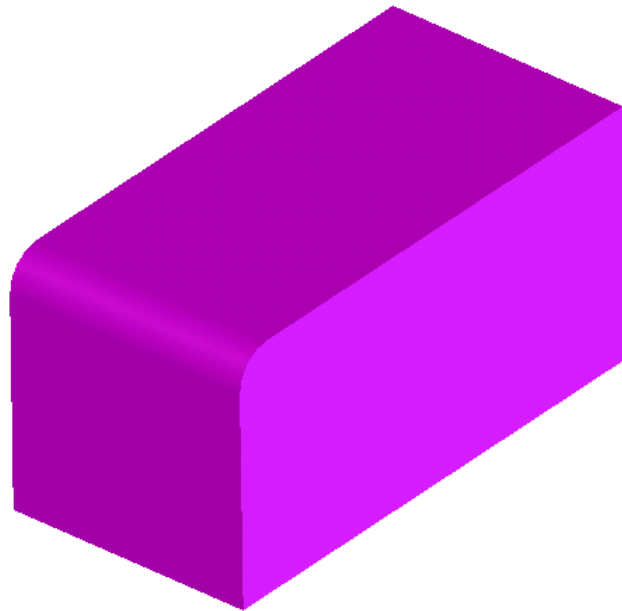

Ký hiệu (Code)
K03-02-03-00

Tên chi tiết (Name of autopart)
KHUÔN TẤM SAU BUỒNG ĐỘNG CƠ

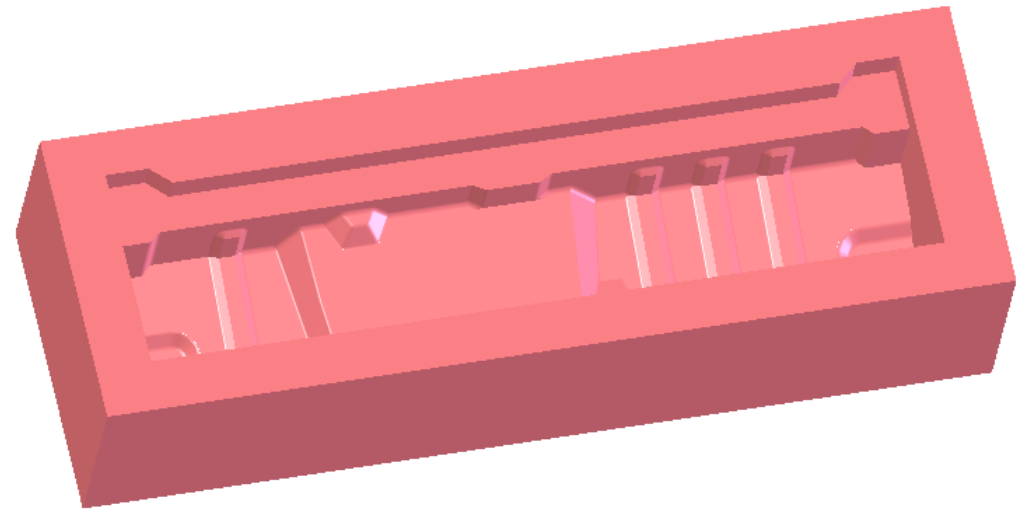
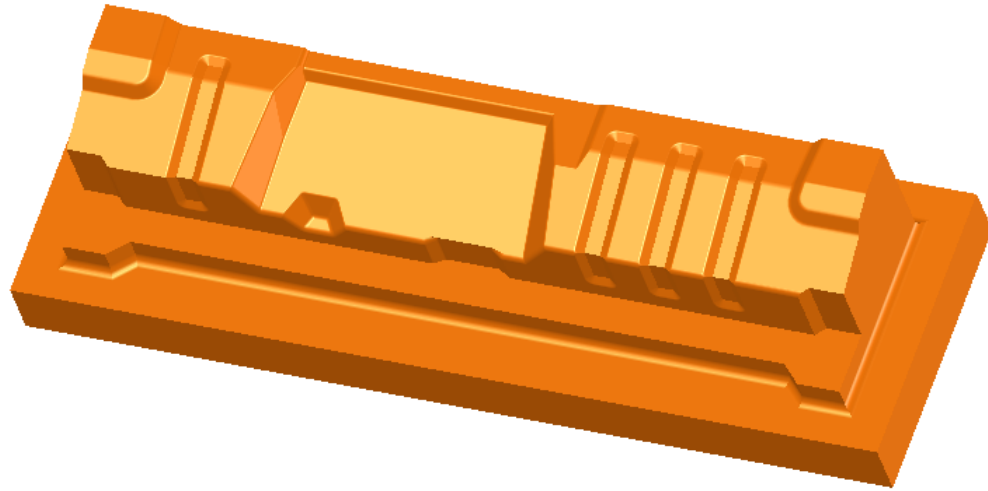

Ký hiệu (Code)
K03-02-03-01

Tên chi tiết (Name of autopart)
KHUÔN TẤM ỐP ĐỆM

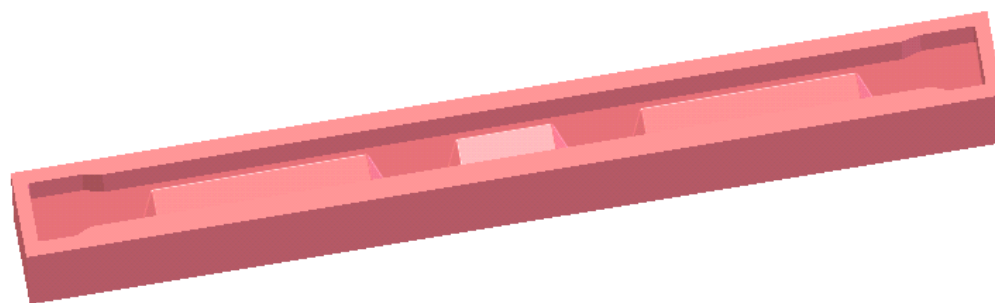
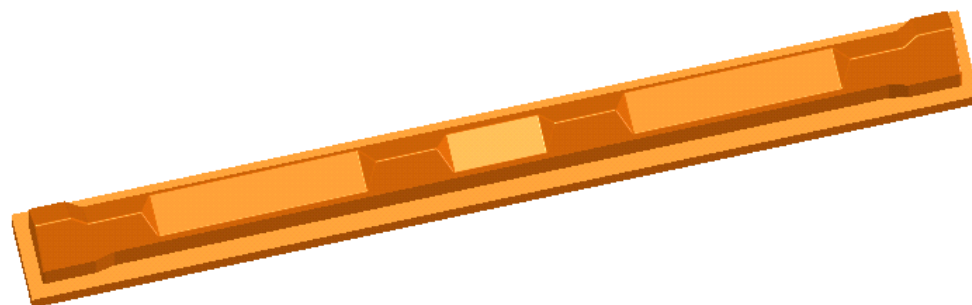

Ký hiệu (Code)
K03-02-04-00

Tên chi tiết (Name of autopart)
KHUÔN TẤM SÀN

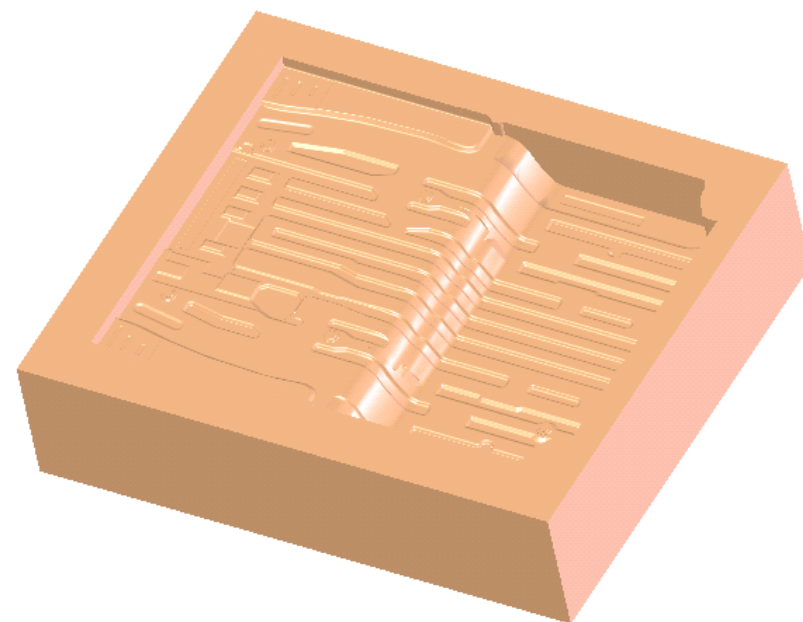
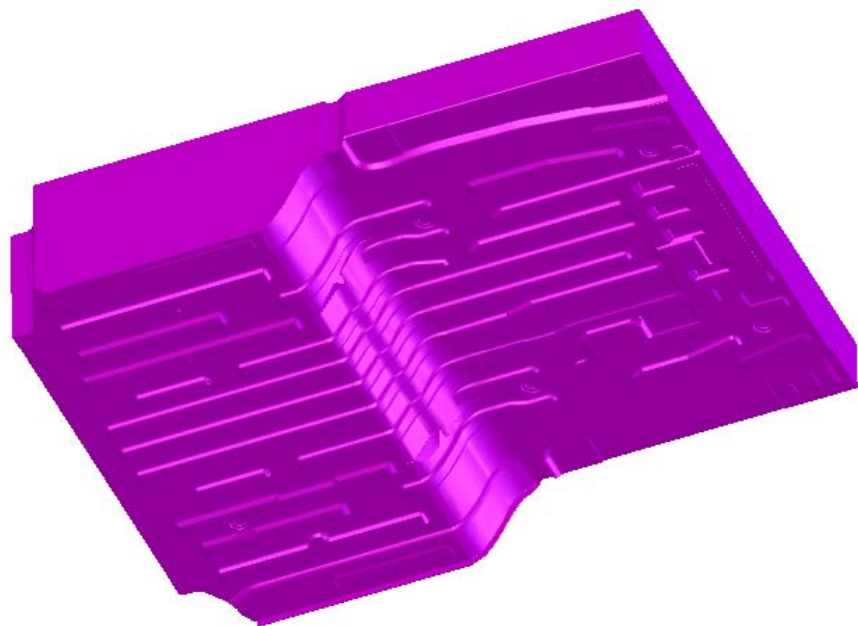

Ký hiệu (Code)
K03-02-04-01

Tên chi tiết (Name of autopart)
KHUÔN TẤM ĐƯỜNG TRƯỢT CỦA PHẢI

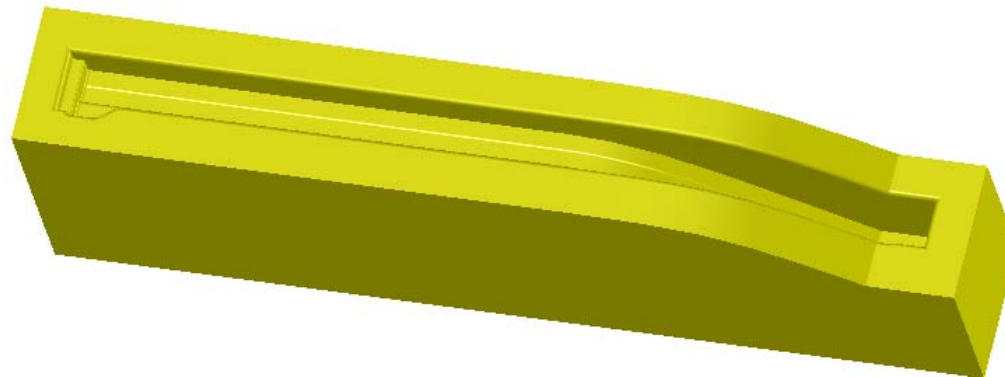
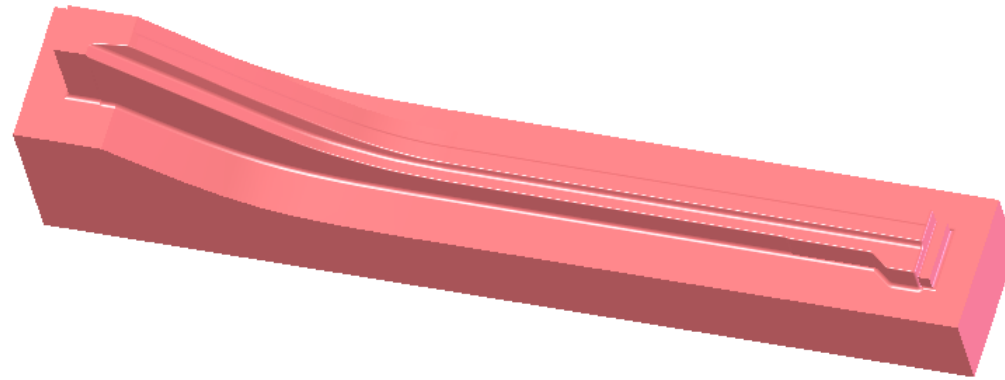

Ký hiệu (Code)
K03-02-04-01-01

Tên chi tiết (Name of autopart)
KHUÔN TẤM ĐỒ DƯỠI

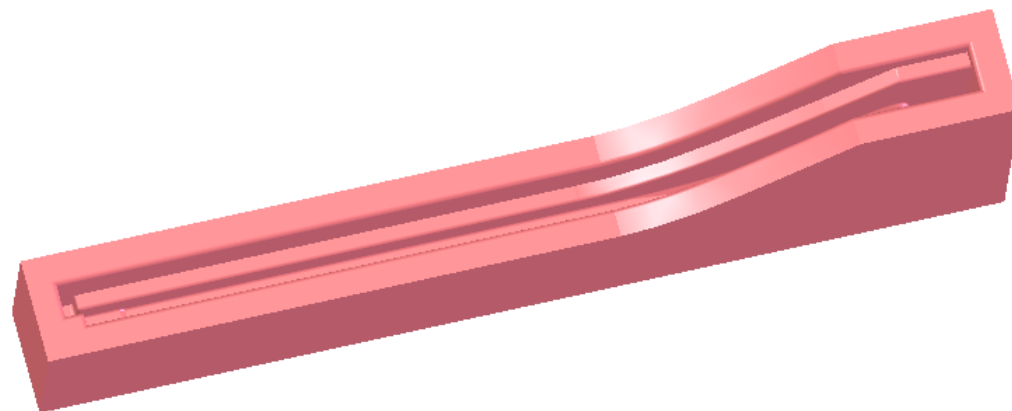
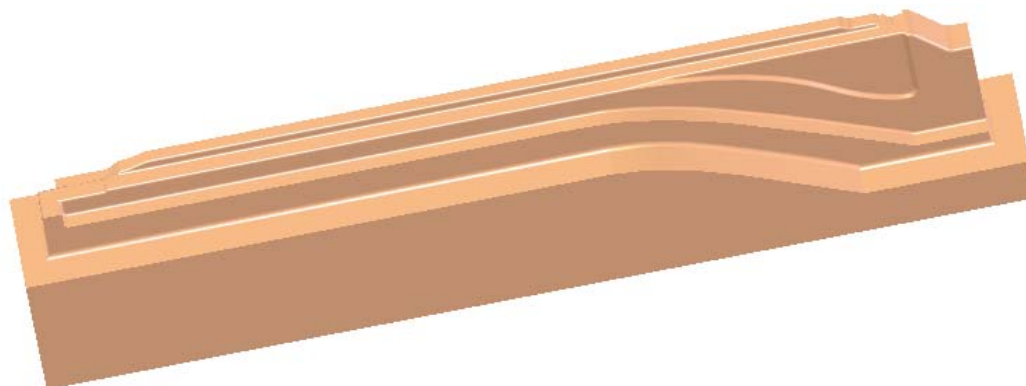

Ký hiệu (Code)
K03-02-04-01-02

Tên chi tiết (Name of autopart)
KHUÔN TẤM ĐẦU

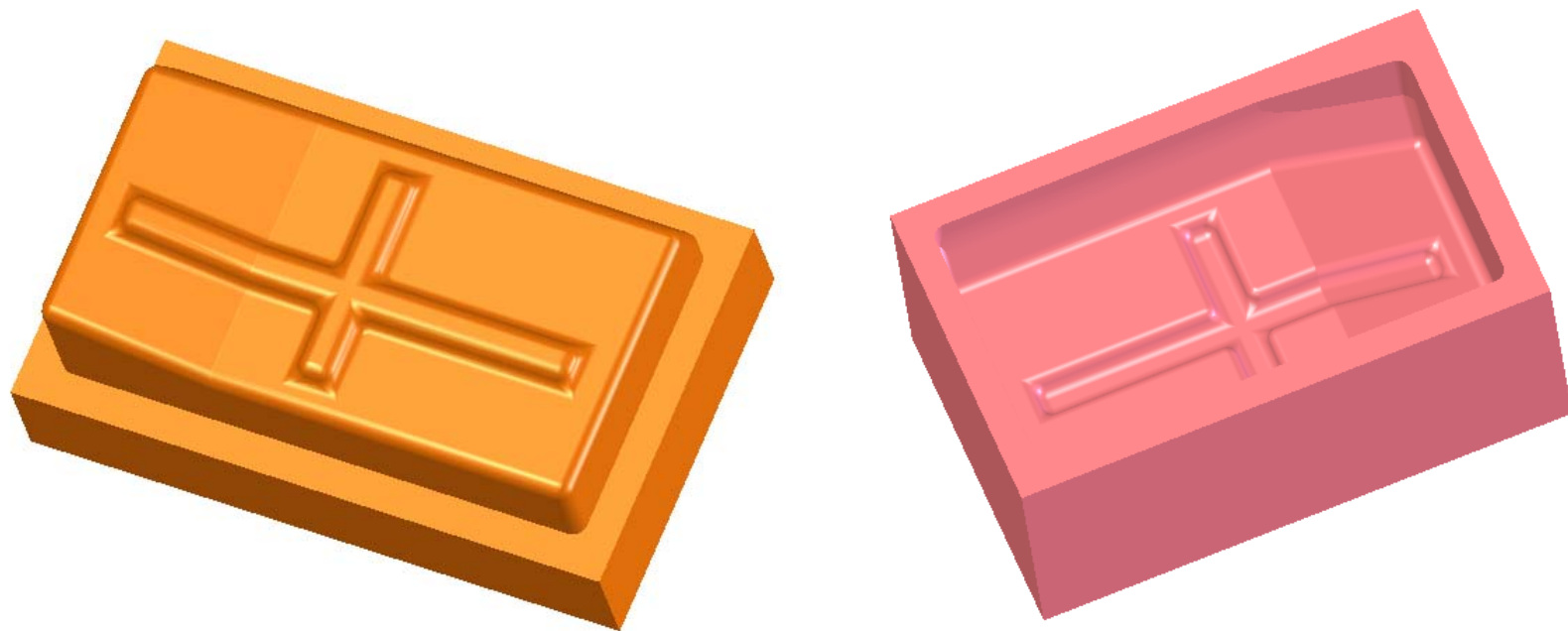

Ký hiệu (Code)
K03-02-04-01-03

Tên chi tiết (Name of autopart)
KHUÔN TẤM ĐỒ TRÊN

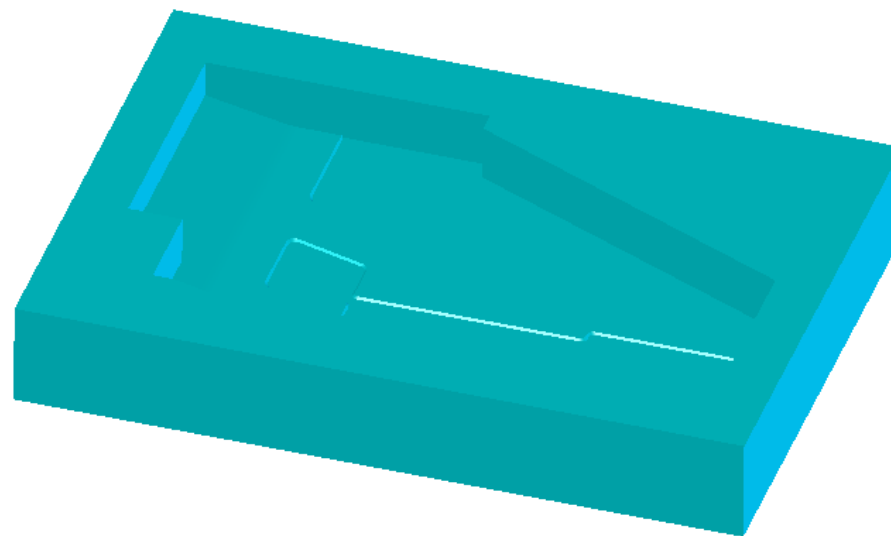
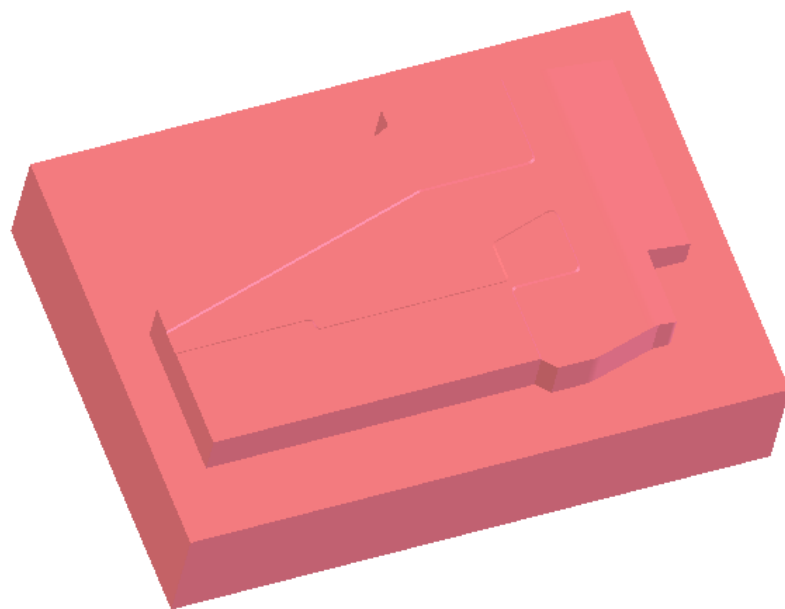

Ký hiệu (Code)
K03-02-04-02

Tên chi tiết (Name of autopart)
KHUÔN TẮM ĐƯỜNG TRƯỢT CỦA TRÁI

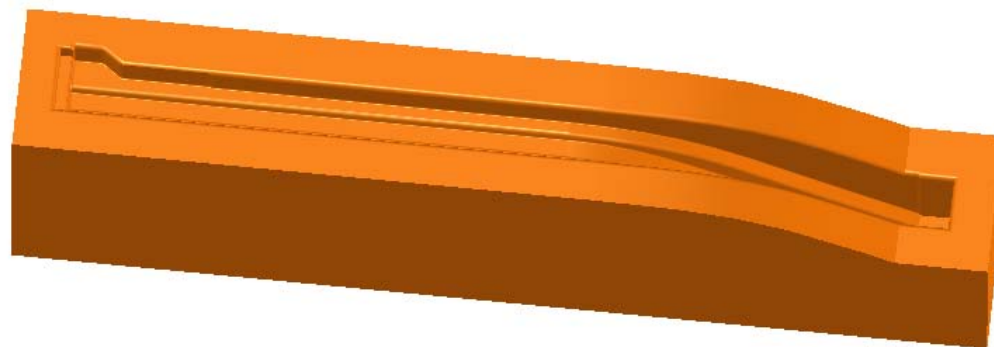
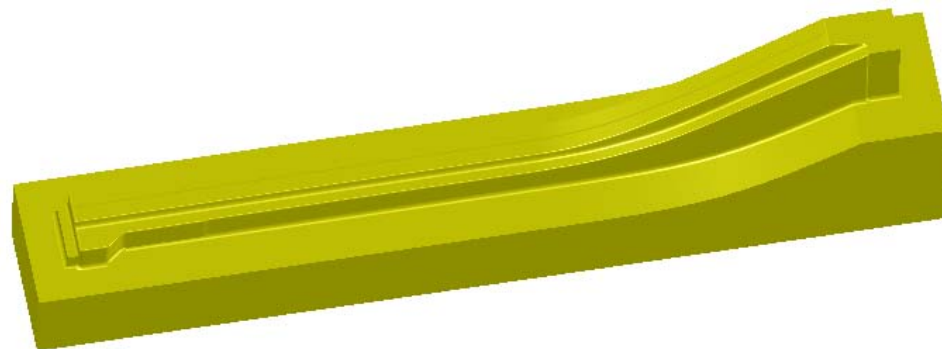

Ký hiệu (Code)
K03-02-04-02-01

Tên chi tiết (Name of autopart)
KHUÔN TẤM ĐỖ DƯỚI

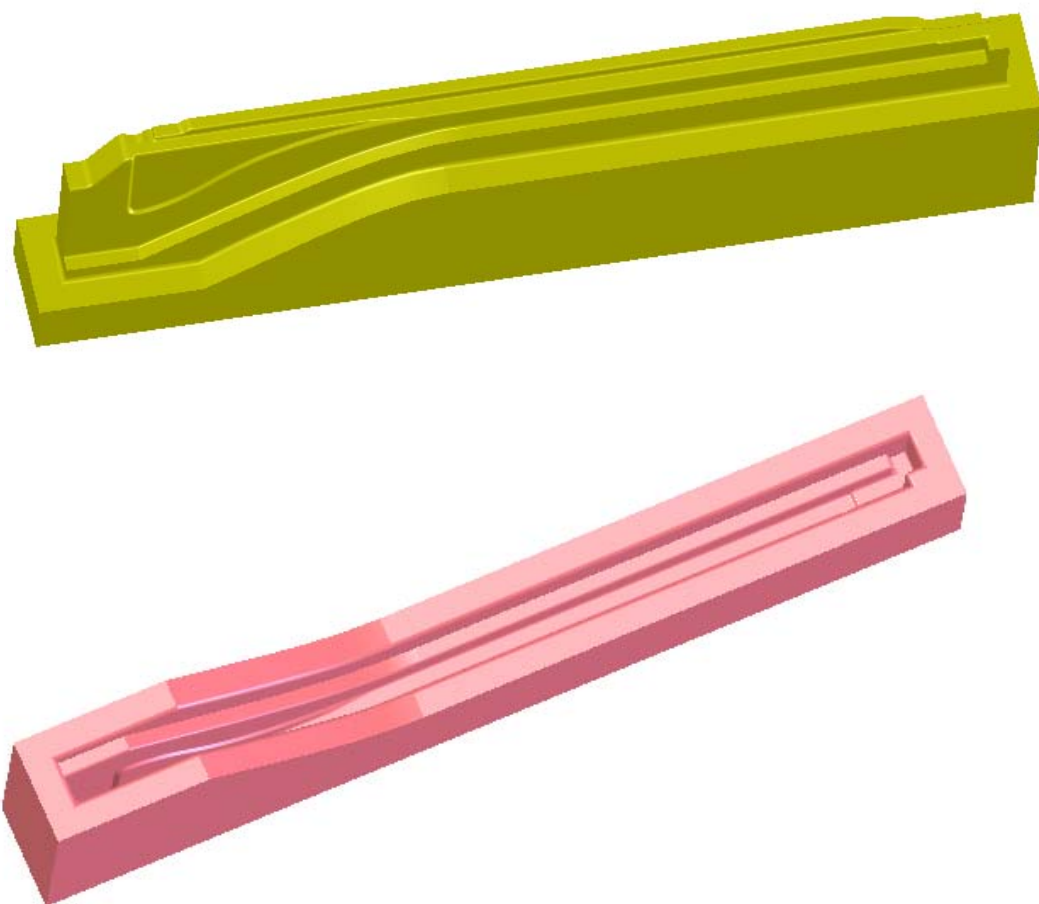

Ký hiệu (Code)
K03-02-04-02-02

Tên chi tiết (Name of autopart)
KHUÔN TẤM ĐẦU

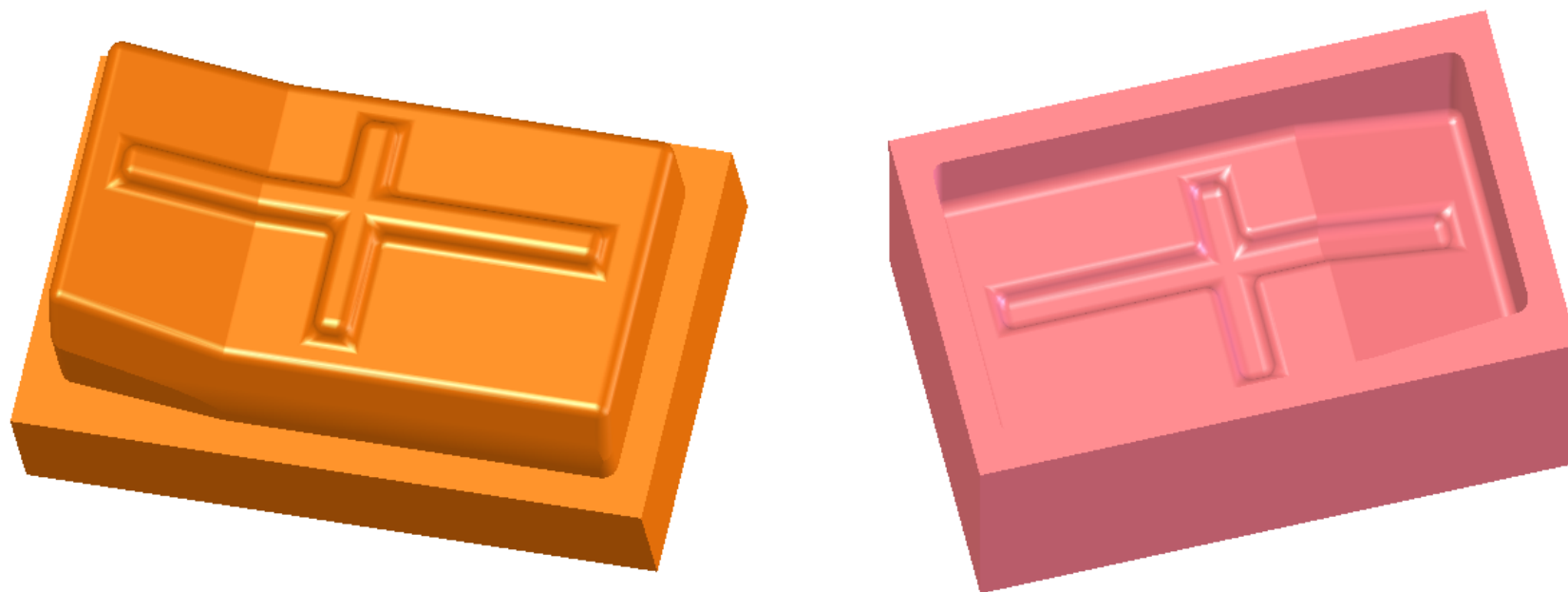

Ký hiệu (Code)
K03-02-04-02-03

Tên chi tiết (Name of autopart)
KHUÔN TẤM ĐỒ TRÊN

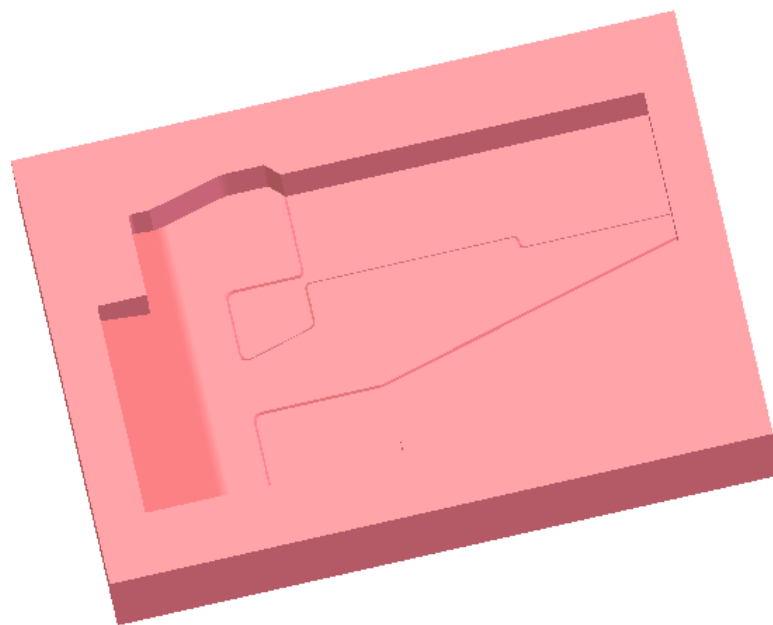
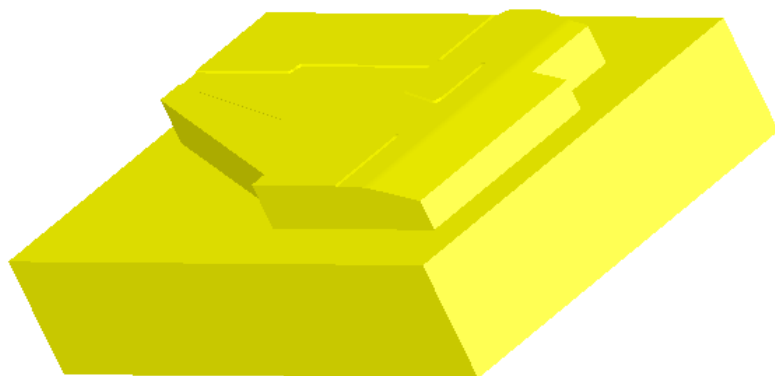

Ký hiệu (Code)
K03-02-04-03

Tên chi tiết (Name of autopart)
KHUÔN TẤM NỐI TRÊN BÊN PHẢI

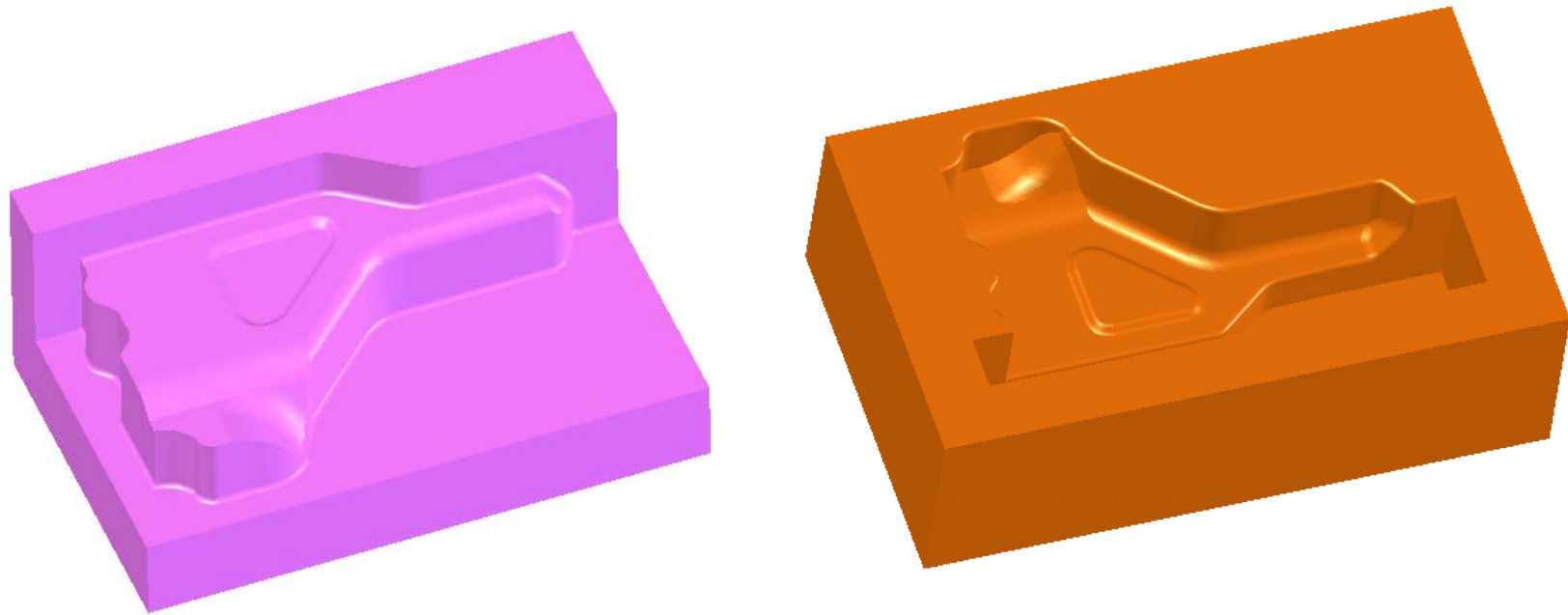

Ký hiệu (Code)
K03-02-04-04

Tên chi tiết (Name of autopart)
KHUÔN TẤM NỐI TRÊN BÊN TRÁI

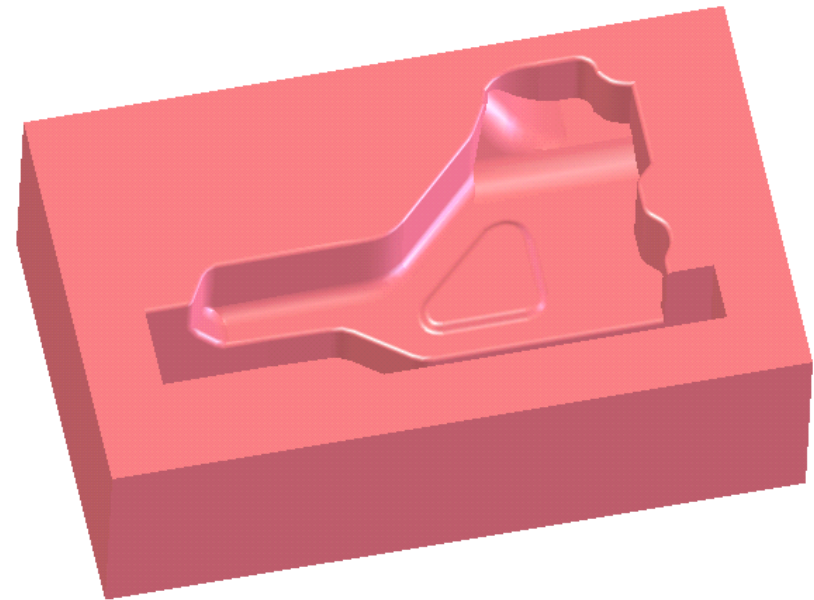
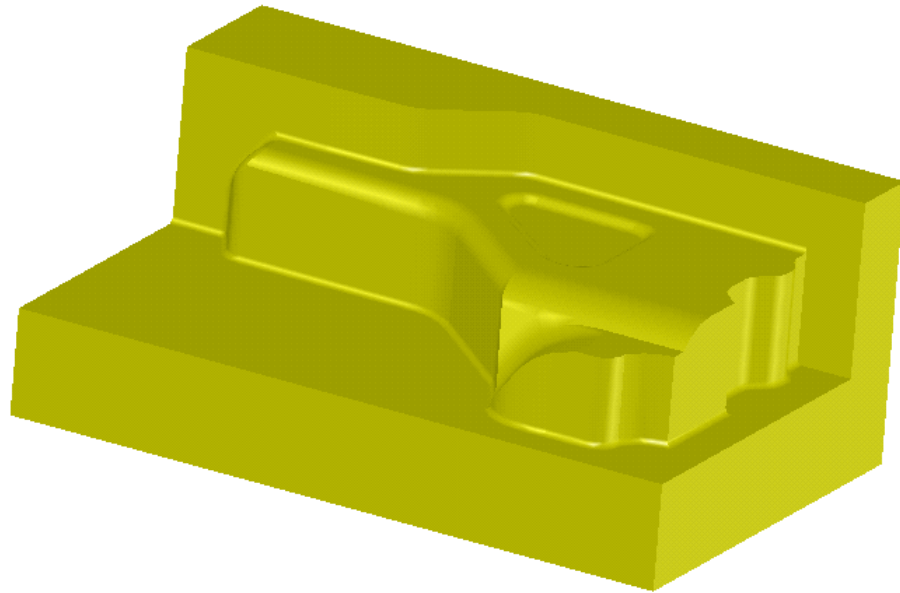

Ký hiệu (Code)
K03-02-04-07

Tên chi tiết (Name of autopart)
KHUÔN MIẾNG ĐỆM GÓC PHẢI SAU

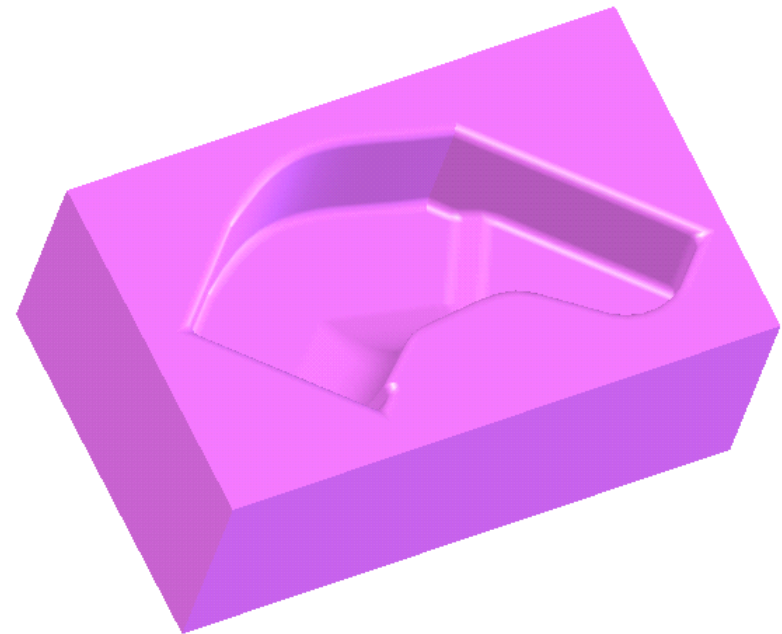
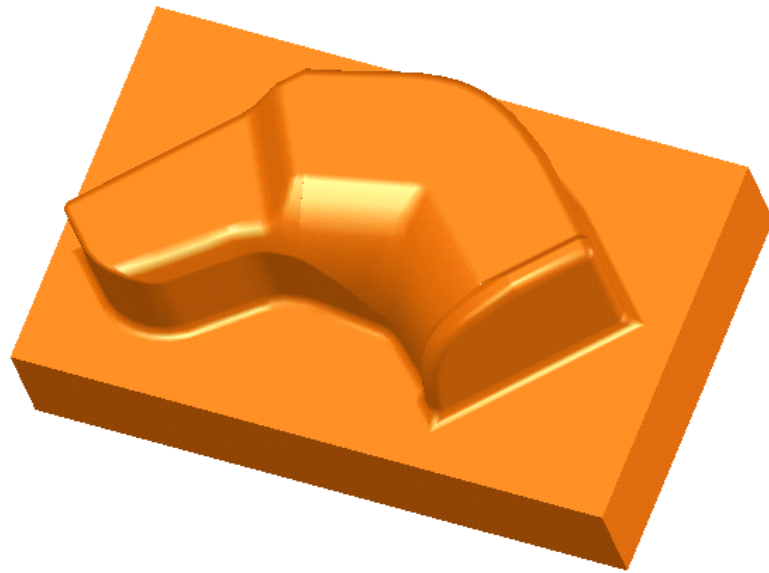

Ký hiệu (Code)
K03-02-04-08

Tên chi tiết (Name of autopart)
KHUÔN MIẾNG ĐỆM GÓC TRÁI SAU

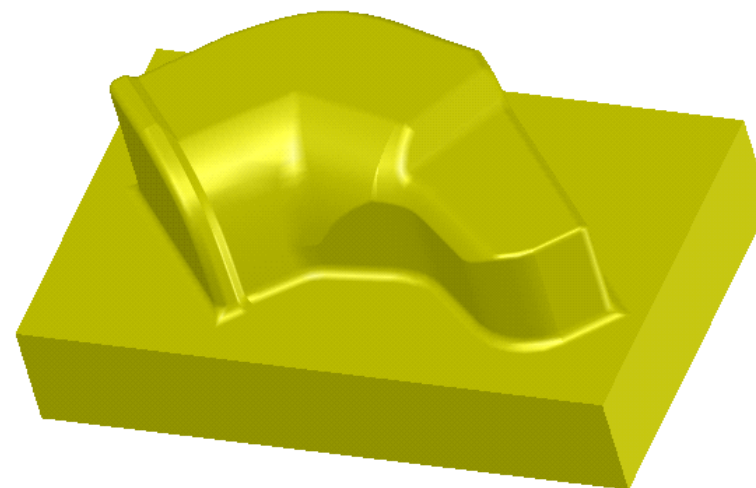
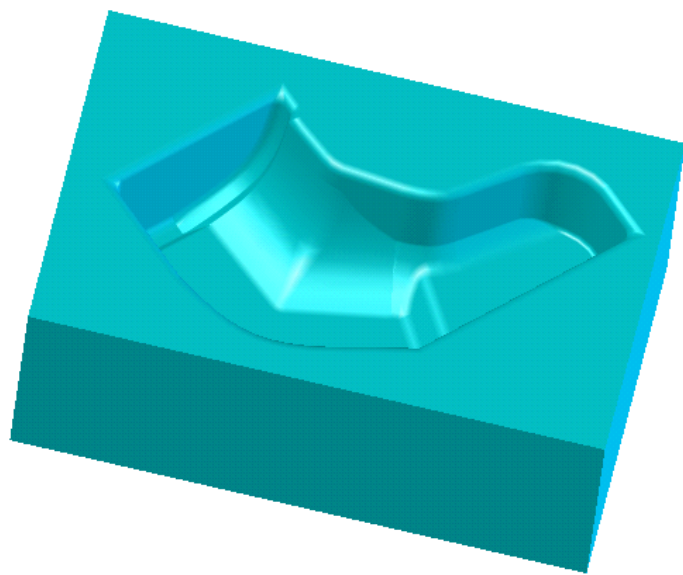

Ký hiệu (Code)
K03-02-05-00

Tên chi tiết (Name of autopart)
KHUÔN THANH NGANG ĐỖ DƯỚI SÀN

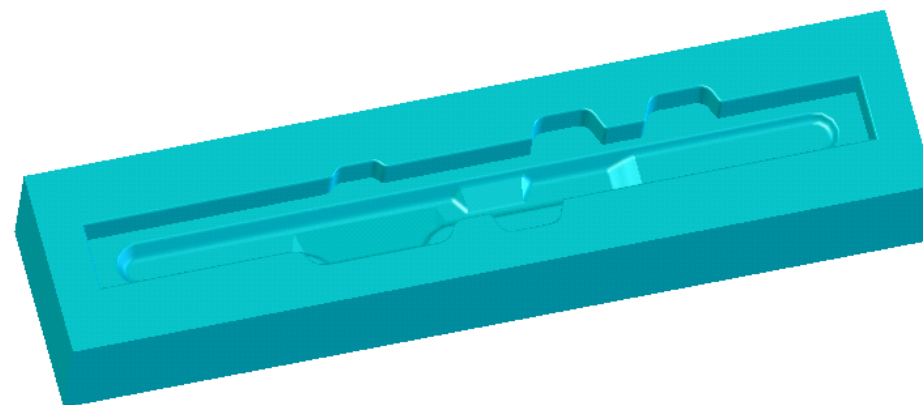
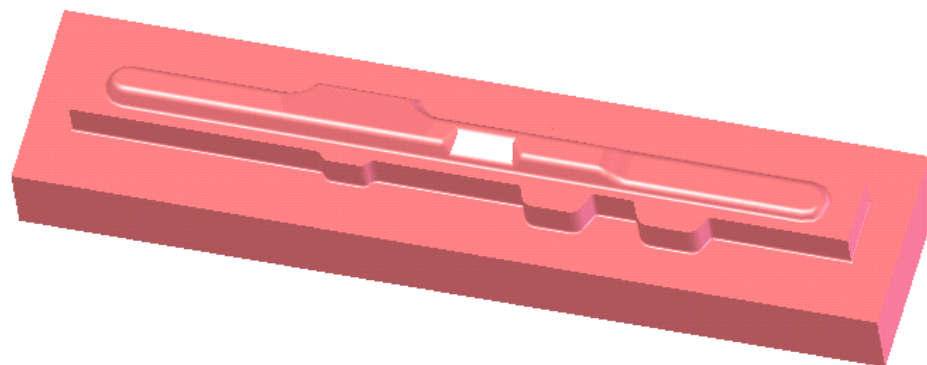

Ký hiệu (Code)
K03-02-06-00

Tên chi tiết (Name of autopart)
KHUÔN TẤM NGANG ĐỖ DƯỚI SÀN

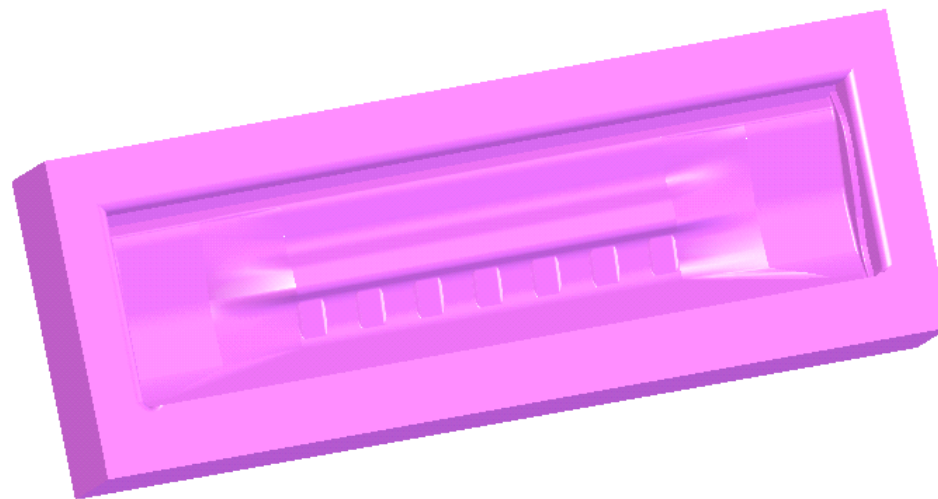

Ký hiệu (Code)
K03-02-07-00

Tên chi tiết (Name of autopart)
KHUÔN TẤM ỐP HẬU

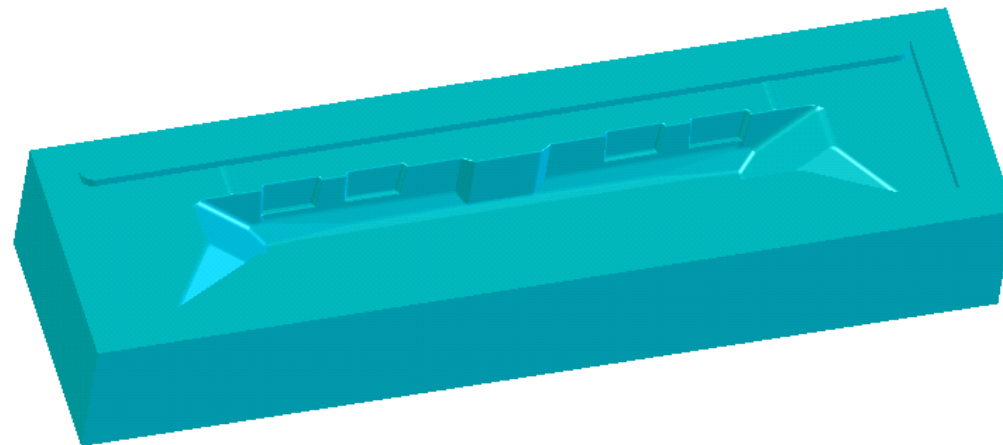
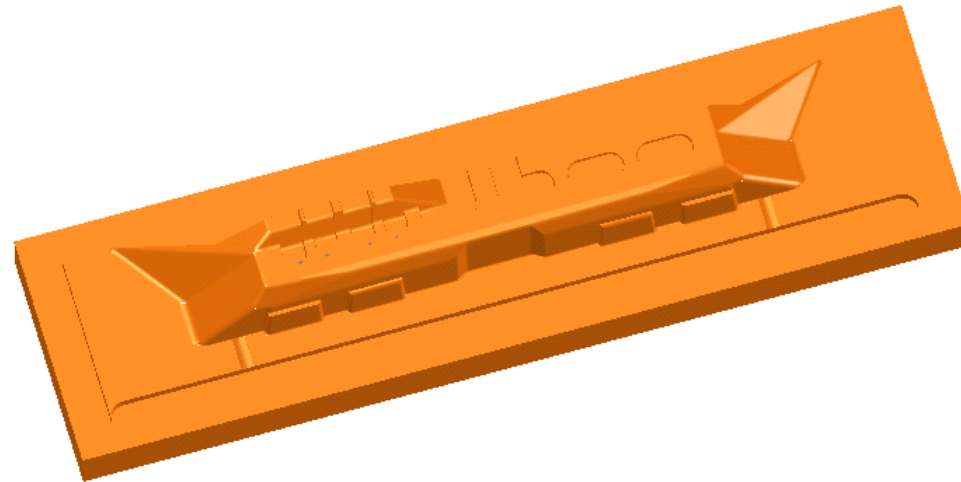

Ký hiệu (Code)
K03-02-07-01

Tên chi tiết (Name of autopart)
KHUÔN TẤM LÓT TĂNG CỨNG

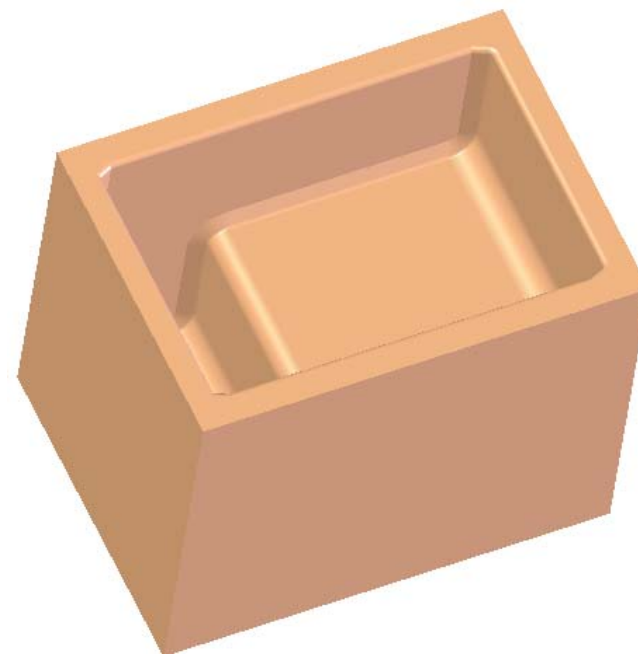

Ký hiệu (Code)
K03-02-07-01-01

Tên chi tiết (Name of autopart)
KHUÔN MIẾNG ỐP

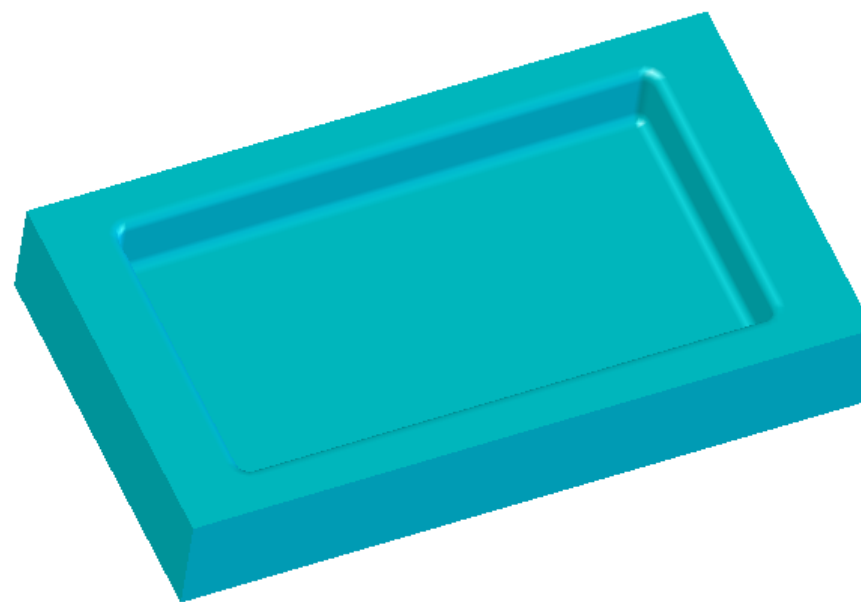
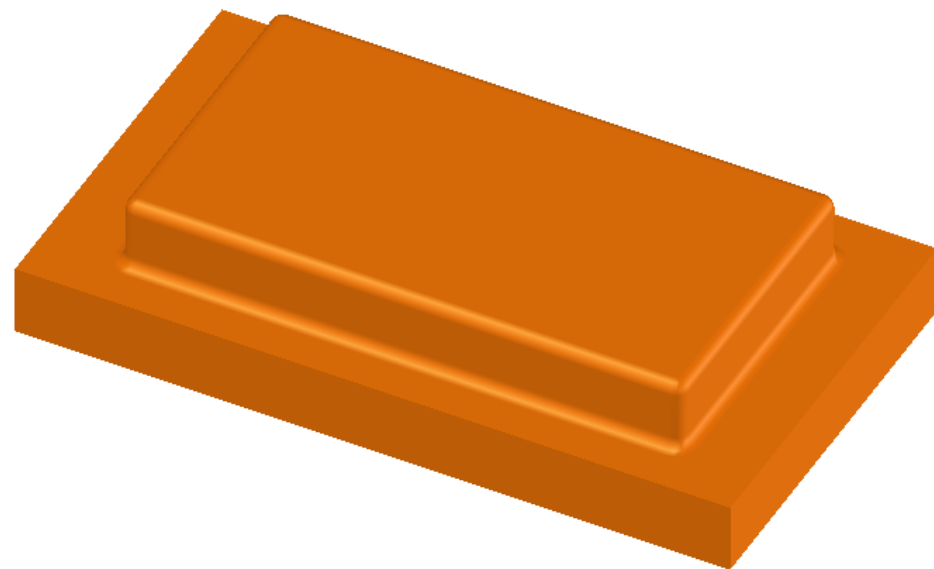

Ký hiệu (Code)
K03-02-08-00

Tên chi tiết (Name of autopart)
KHUÔN Ụ BÁNH TRƯỚC PHẢI

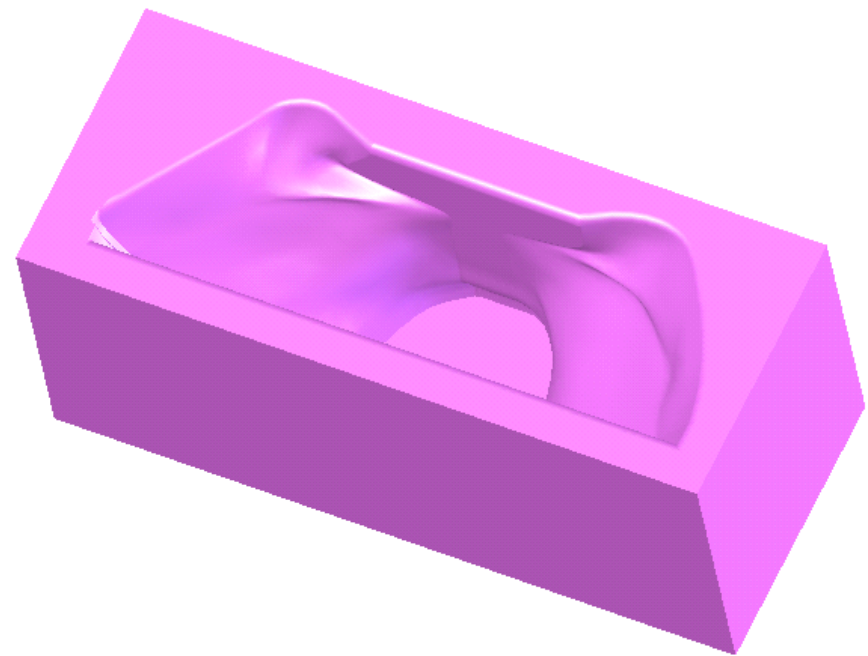
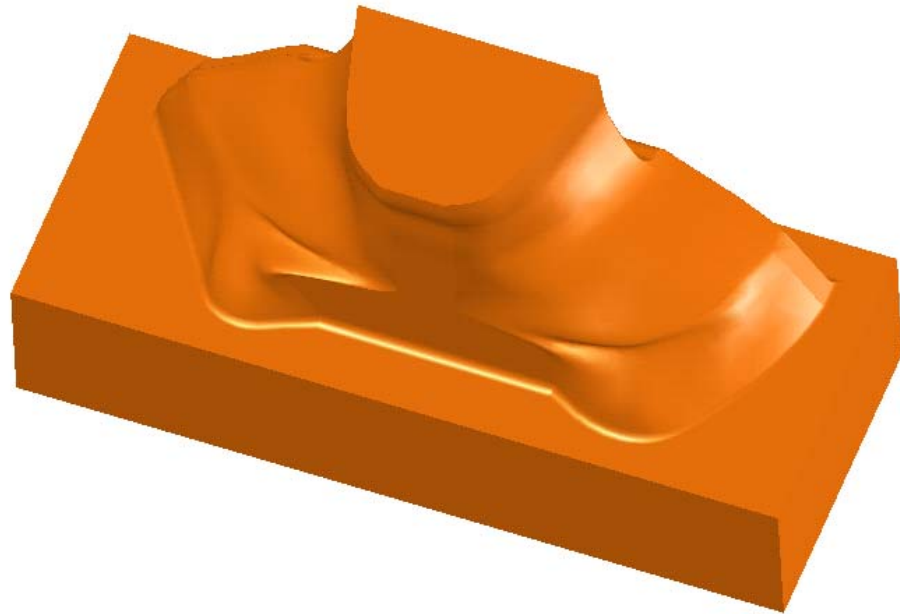

Ký hiệu (Code)
K03-02-08-01

Tên chi tiết (Name of autopart)
KHUÔN GIÁ ĐỖ LÒ XO

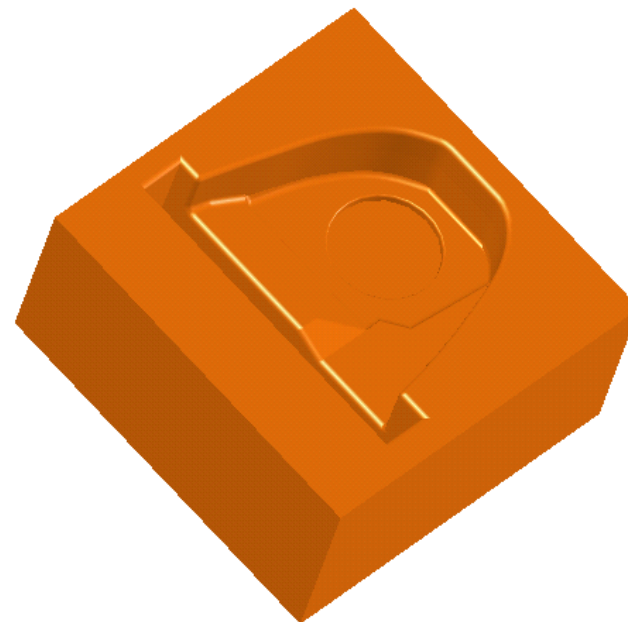
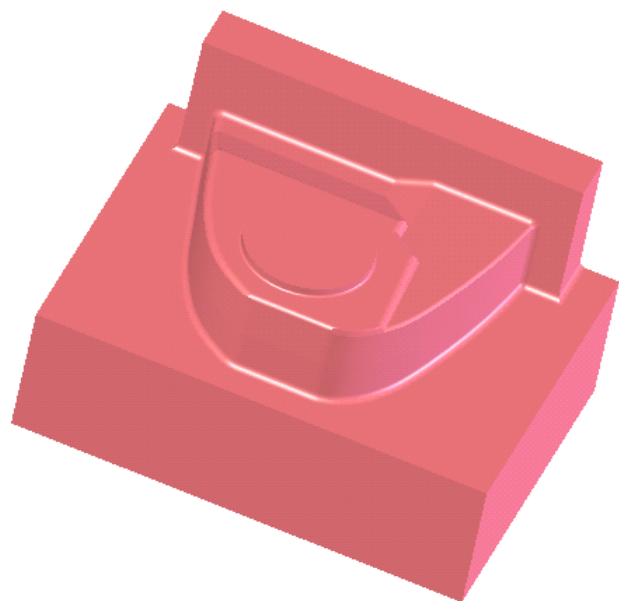

Ký hiệu (Code)
K03-02-08-02

Tên chi tiết (Name of autopart)
KHUÔN TẤM BAO NGOÀI

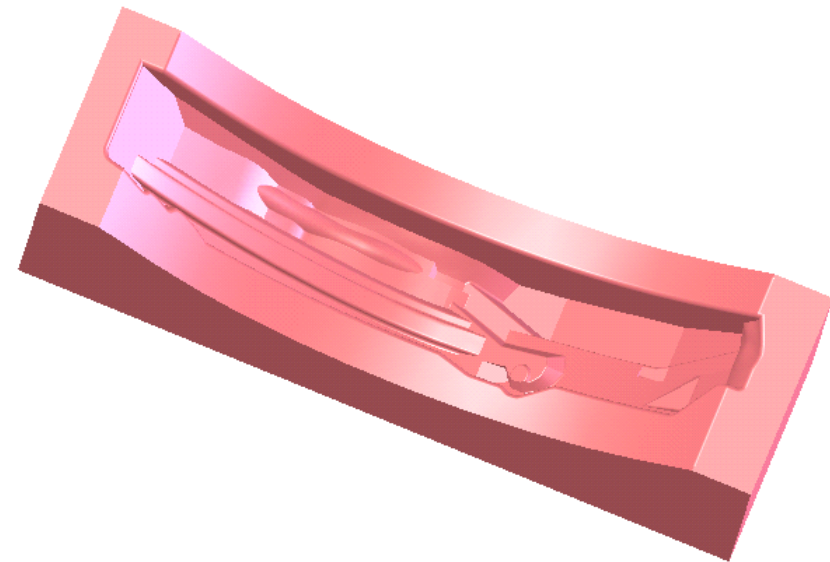
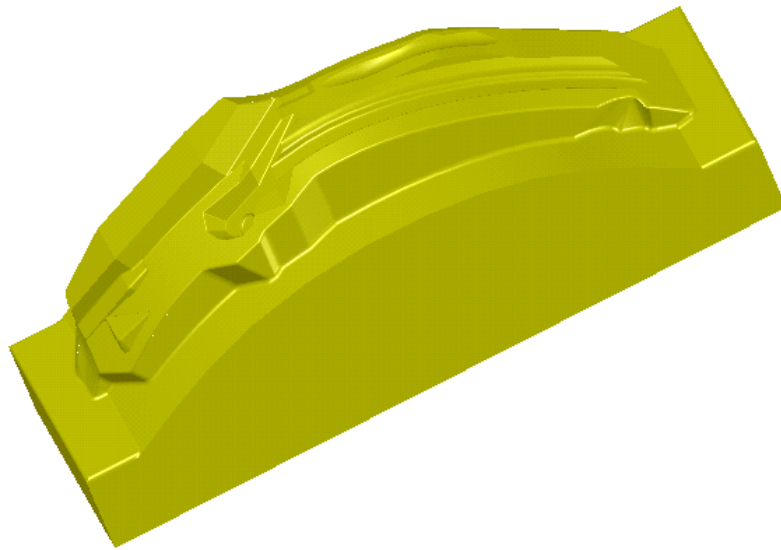

Ký hiệu (Code)
K03-02-09-00

Tên chi tiết (Name of autopart)
KHUÔN Ụ BÁNH TRƯỚC TRÁI

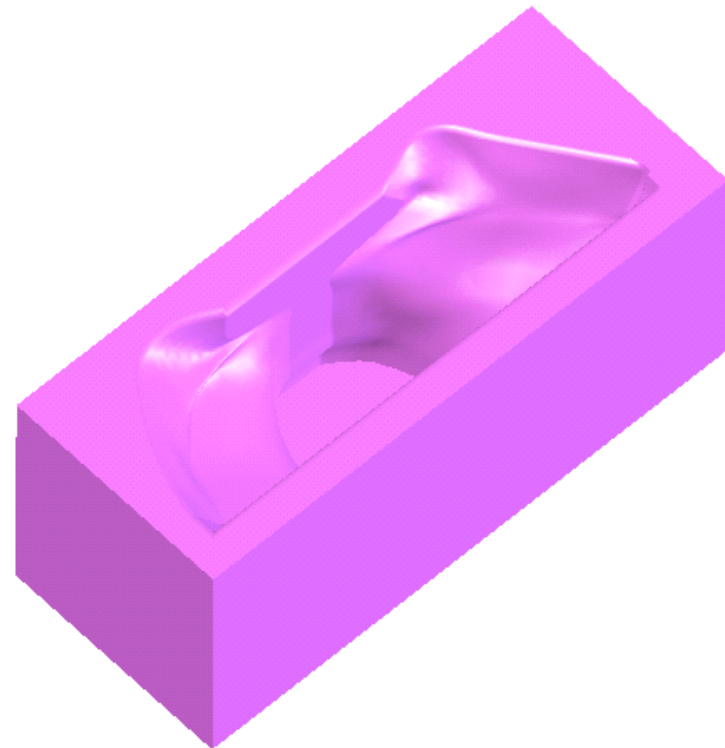
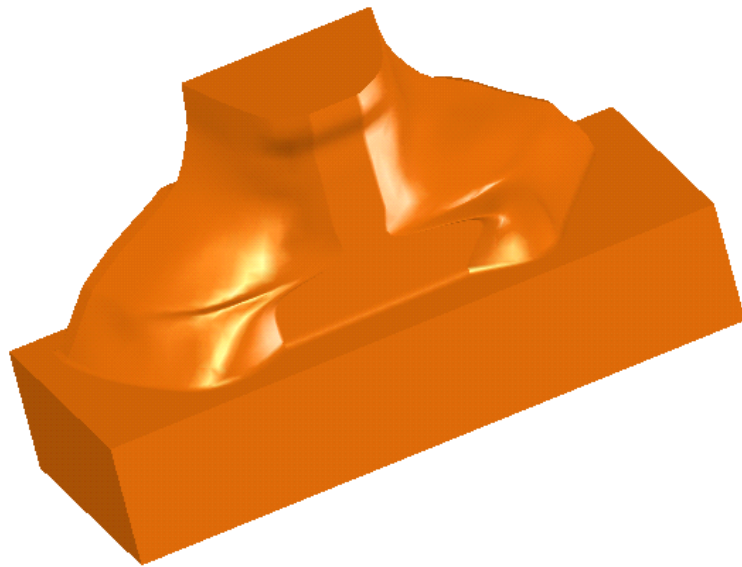

Ký hiệu (Code)
K03-02-09-01

Tên chi tiết (Name of autopart)
KHUÔN GIÁ ĐỠ LÒ XO

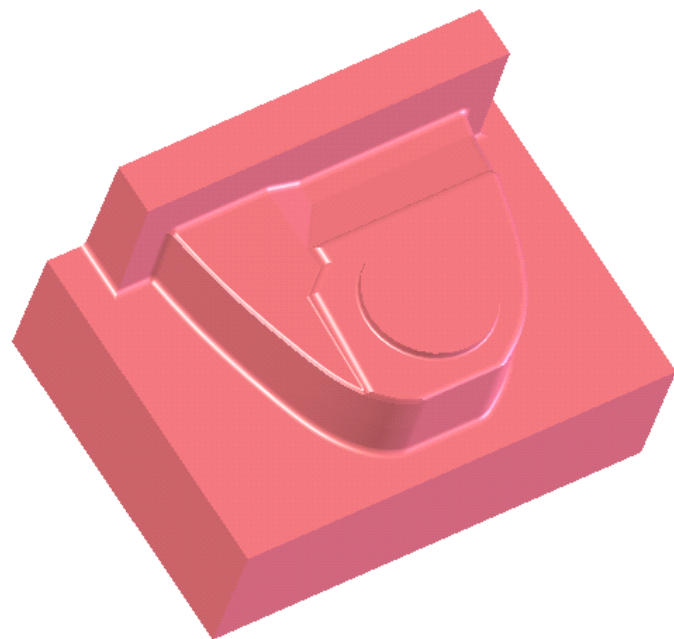

Ký hiệu (Code)
K03-02-09-02

Tên chi tiết (Name of autopart)
KHUÔN TẤM BAO NGOÀI

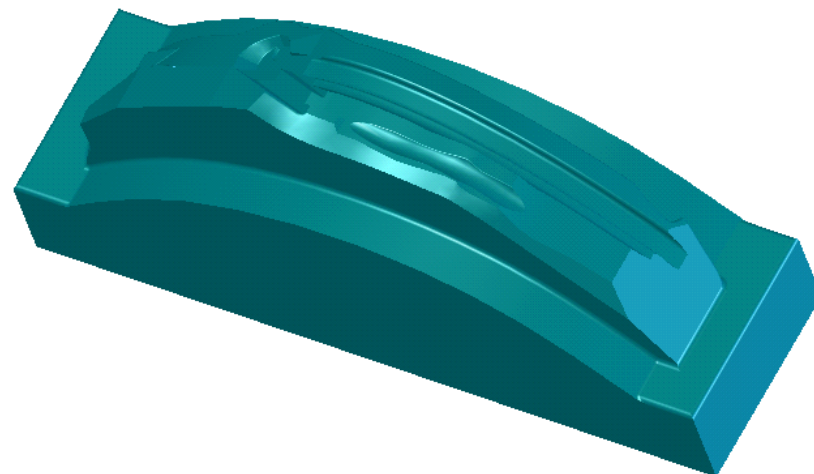
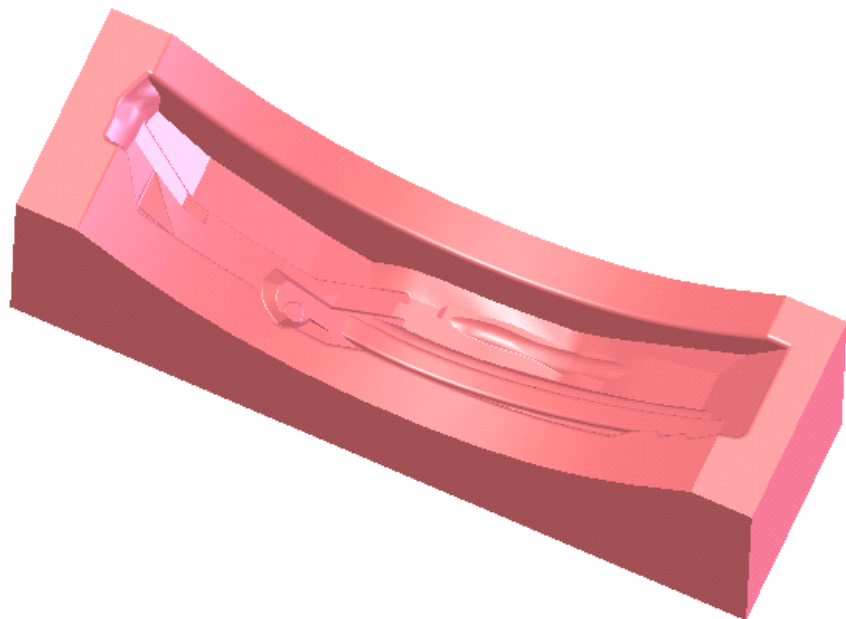

Ký hiệu (Code)
K03-02-10-00

Tên chi tiết (Name of autopart)
KHUÔN TẤM TRÁI BUỒNG ĐỘNG CƠ

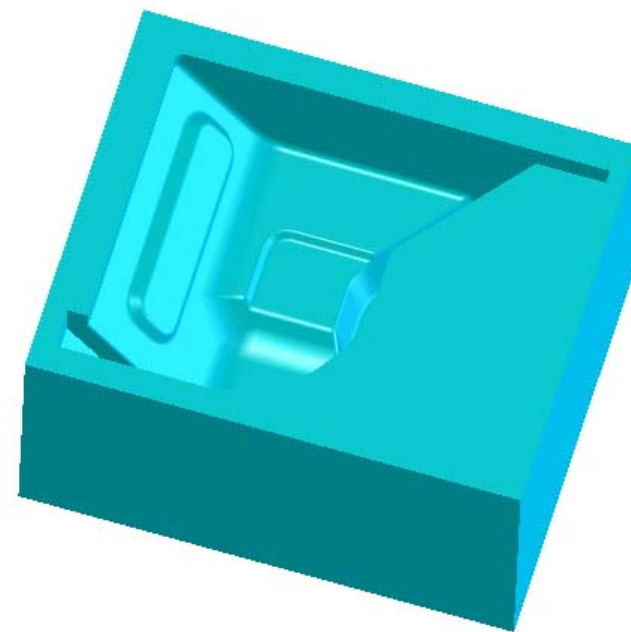
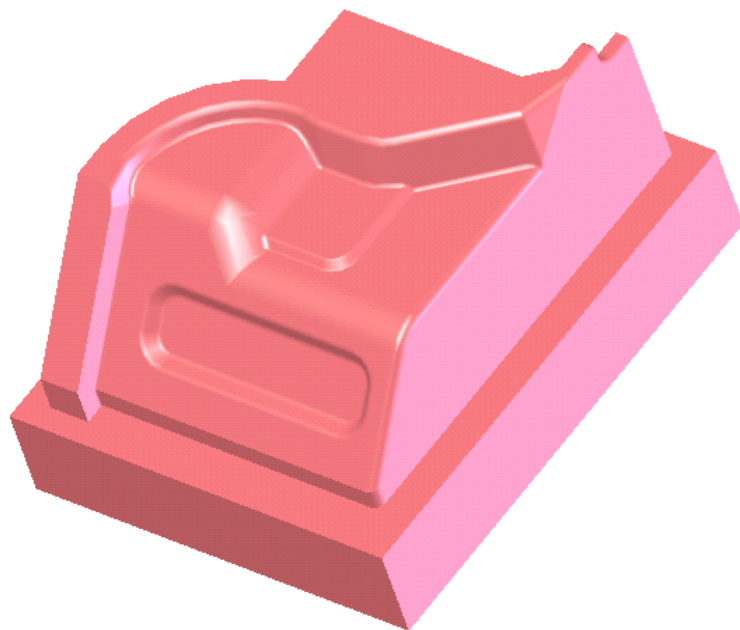

Ký hiệu (Code)
K03-02-10-01

Tên chi tiết (Name of autopart)
KHUÔN MÓC

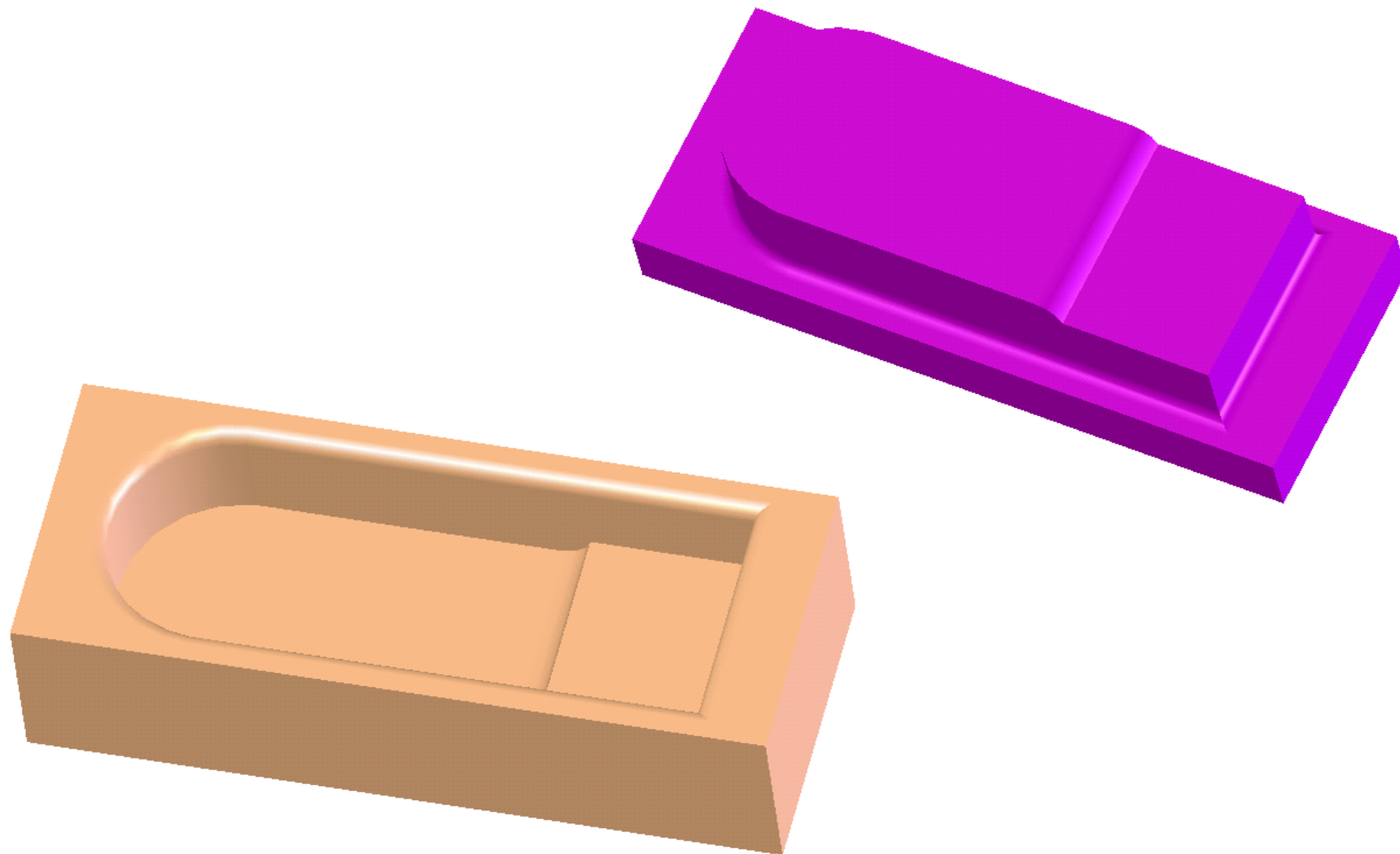

Ký hiệu (Code)
K03-02-11-00

Tên chi tiết (Name of autopart)
KHUÔN TẤM PHẢI BUỒNG ĐỘNG CƠ

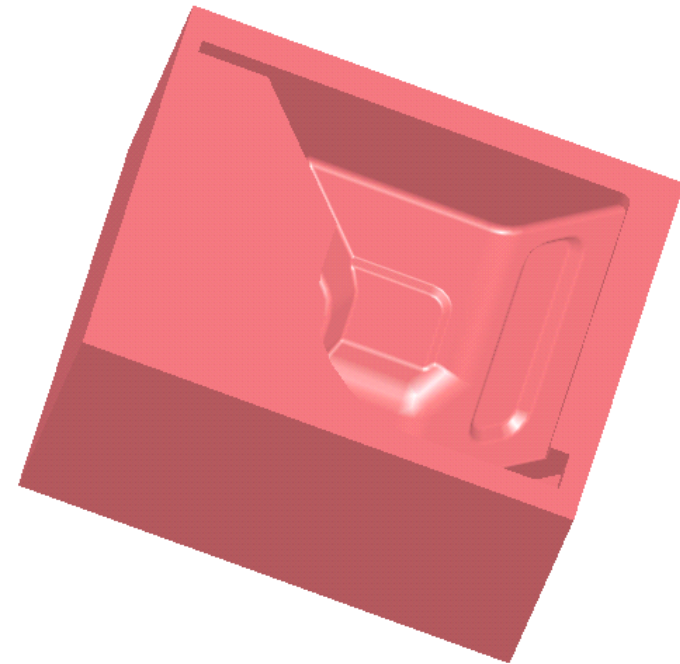
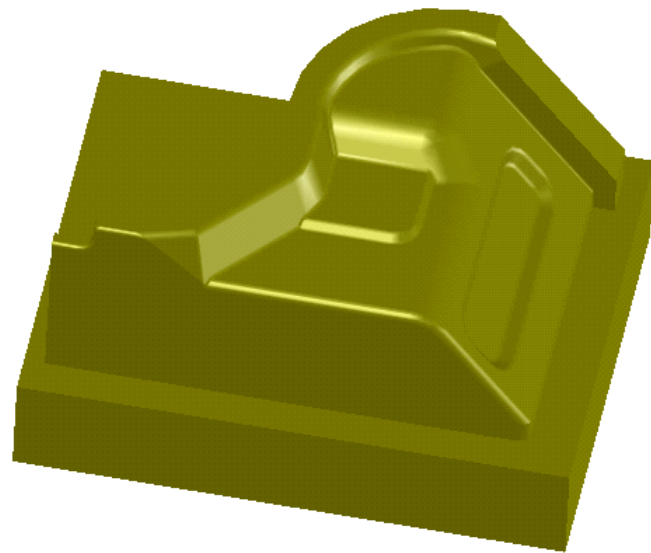

Ký hiệu (Code)
K03-02-11-01

Tên chi tiết (Name of autopart)
KHUÔN MÓC

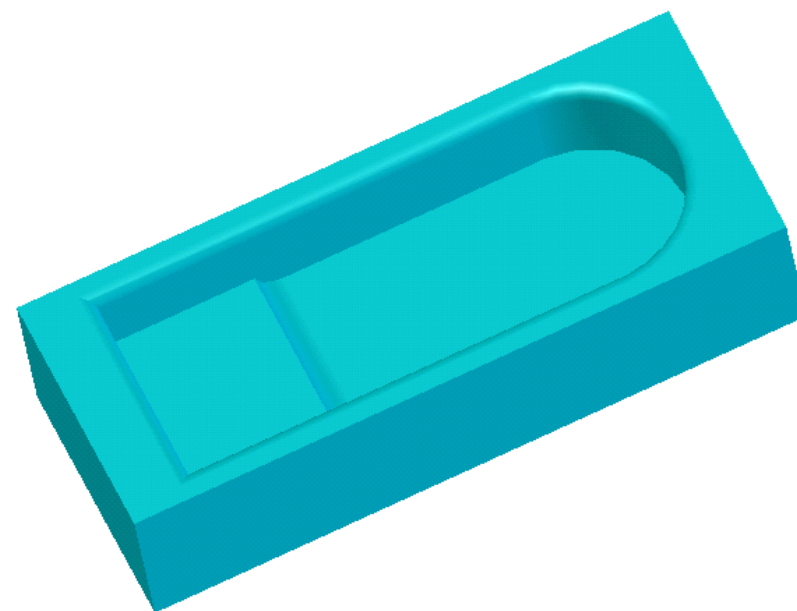
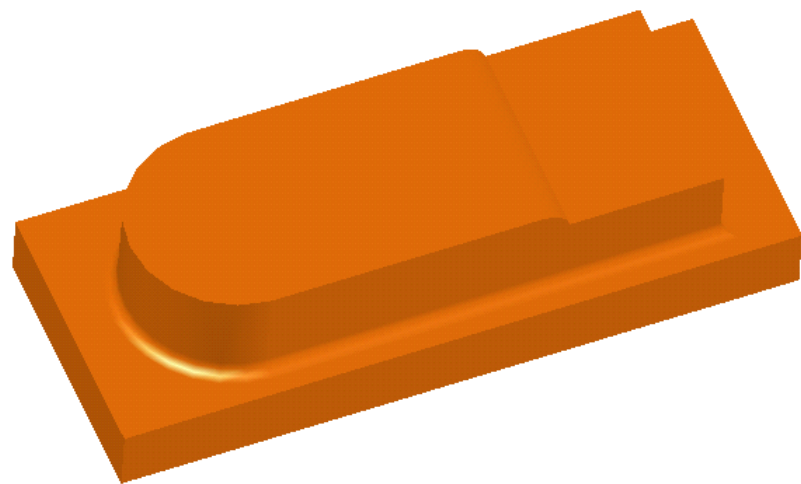

Ký hiệu (Code)
K03-02-13-02

Tên chi tiết (Name of autopart)
KHUÔN ỐNG CỔ THÙNG XĂNG

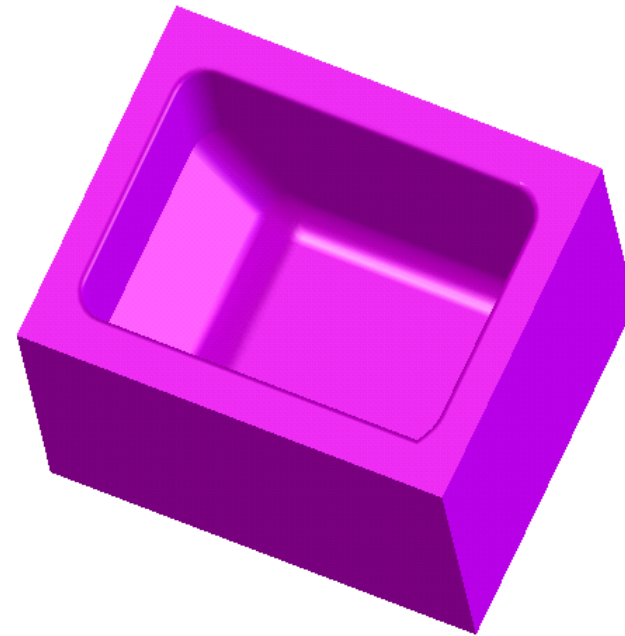
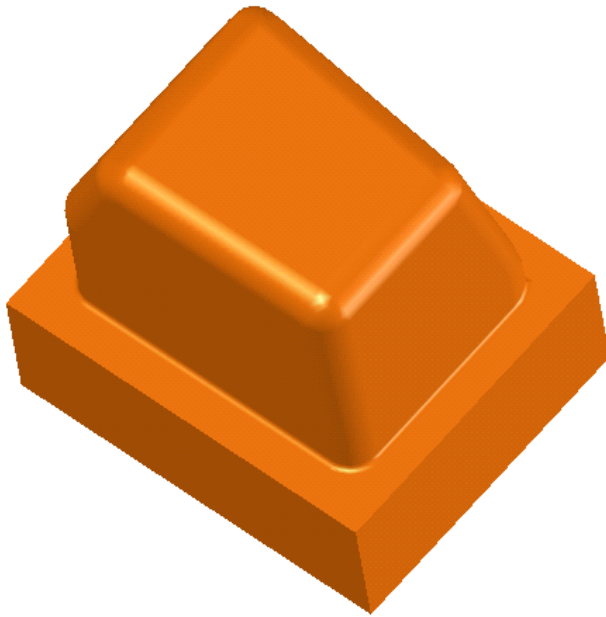

Ký hiệu (Code)
K03-02-14-00

Tên chi tiết (Name of autopart)
KHUÔN TẤM BAO GIỮ PHẢI

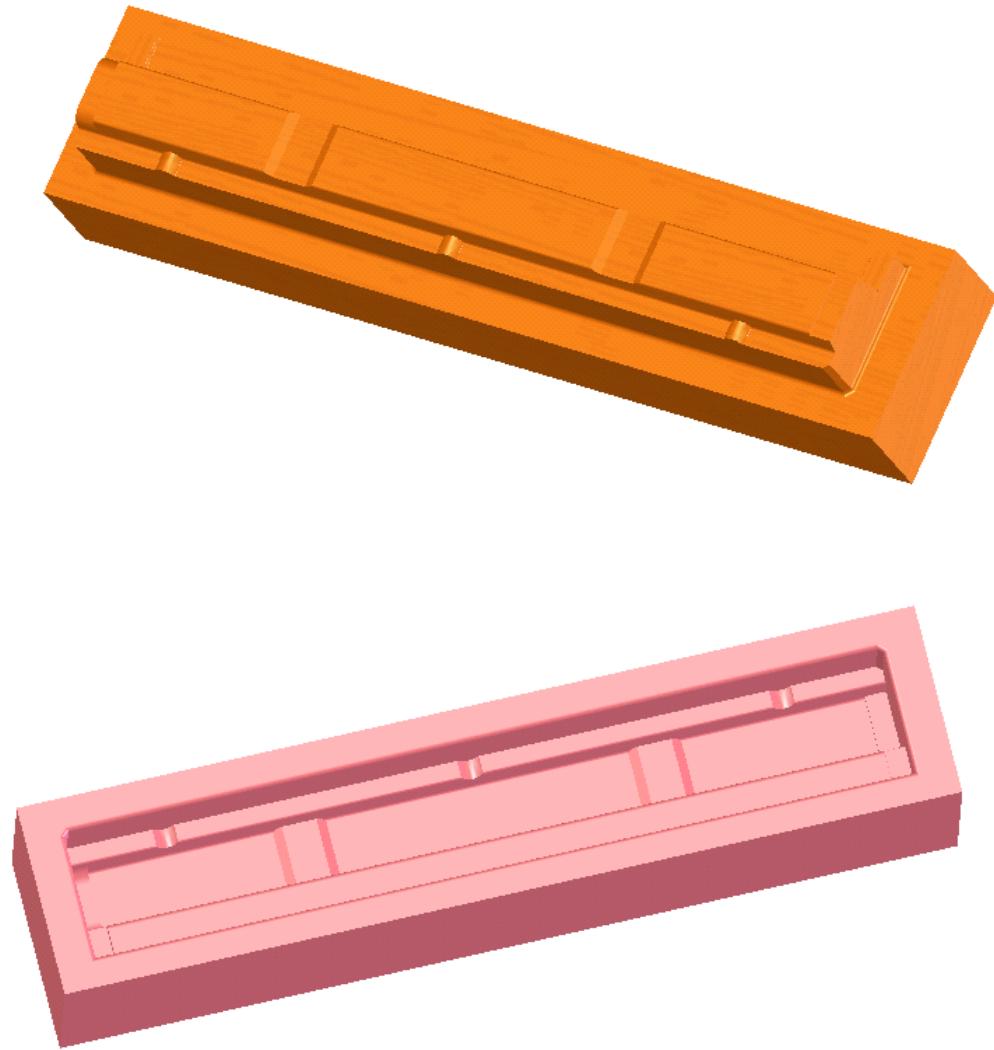

Ký hiệu (Code)
K03-02-15-00

Tên chi tiết (Name of autopart)
KHUÔN TẤM BAO GIỮ TRÁI

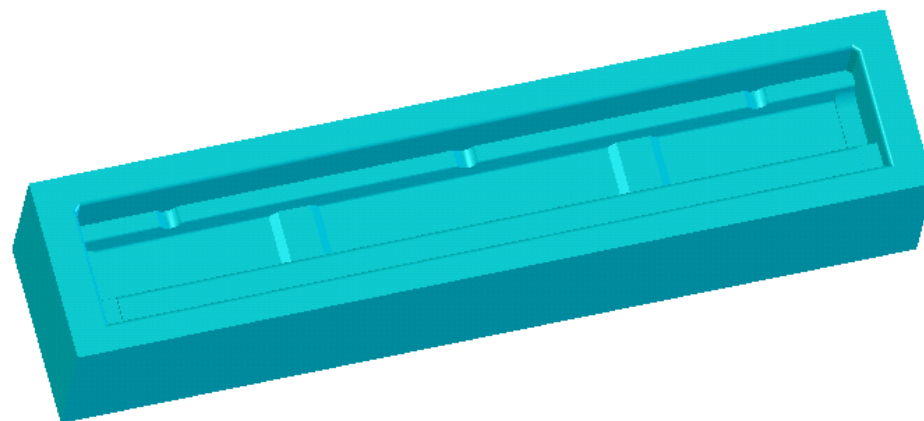
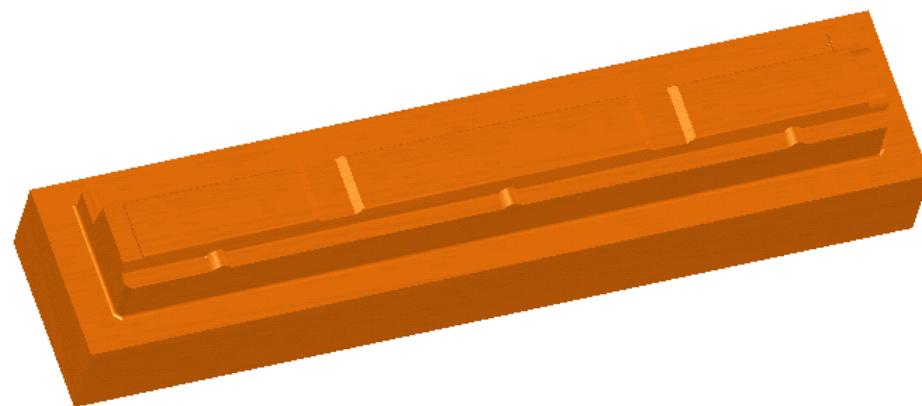

Ký hiệu (Code)
K03-02-16-00

Tên chi tiết (Name of autopart)
KHUÔN BAO NGOÀI BÁNH SAU PHẢI

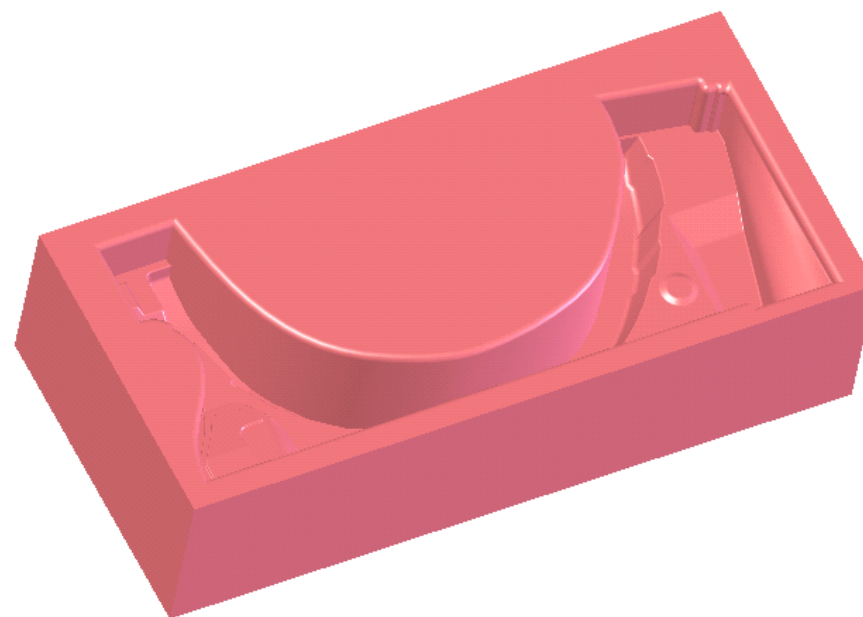
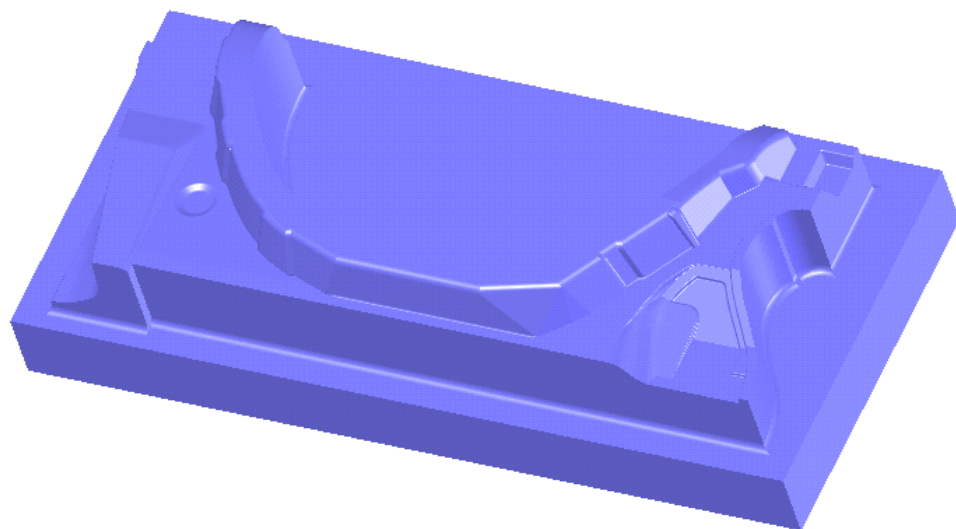

Ký hiệu (Code)
K03-02-16-02

Tên chi tiết (Name of autopart)
KHUÔN TẮM CÁCH

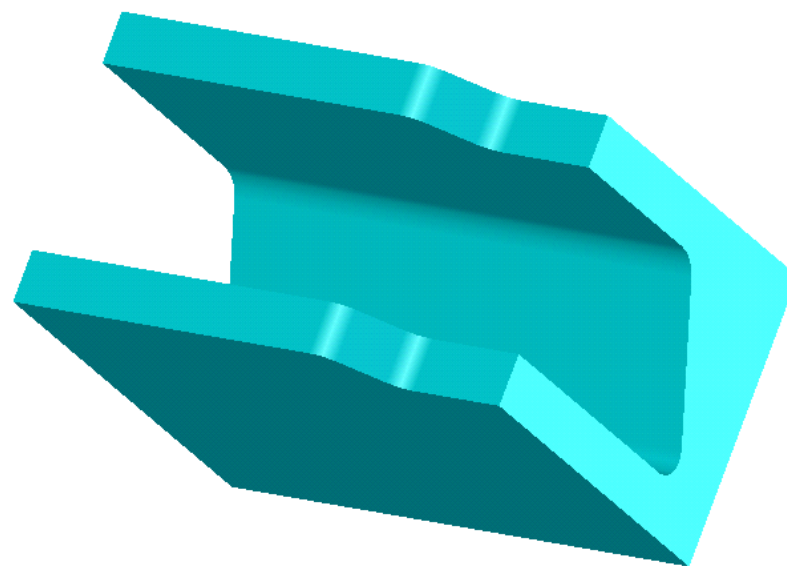
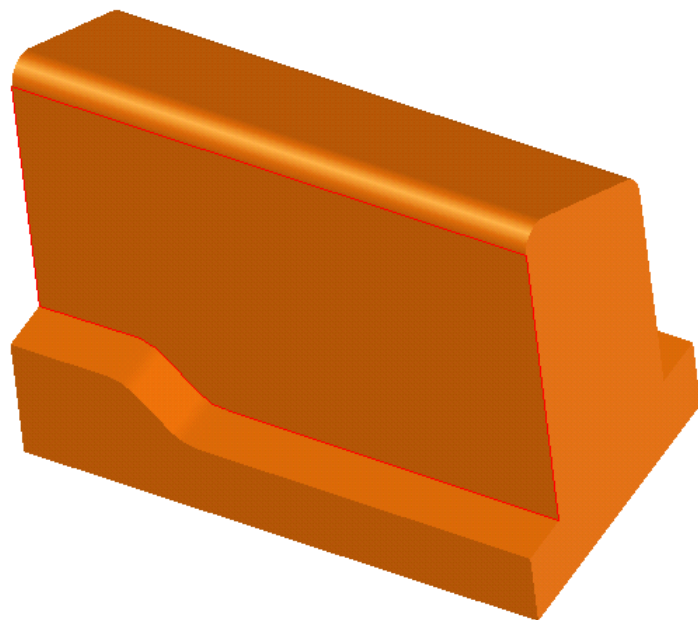

Ký hiệu (Code)
K03-02-16-03

Tên chi tiết (Name of autopart)
KHUÔN TẤM CÁCH

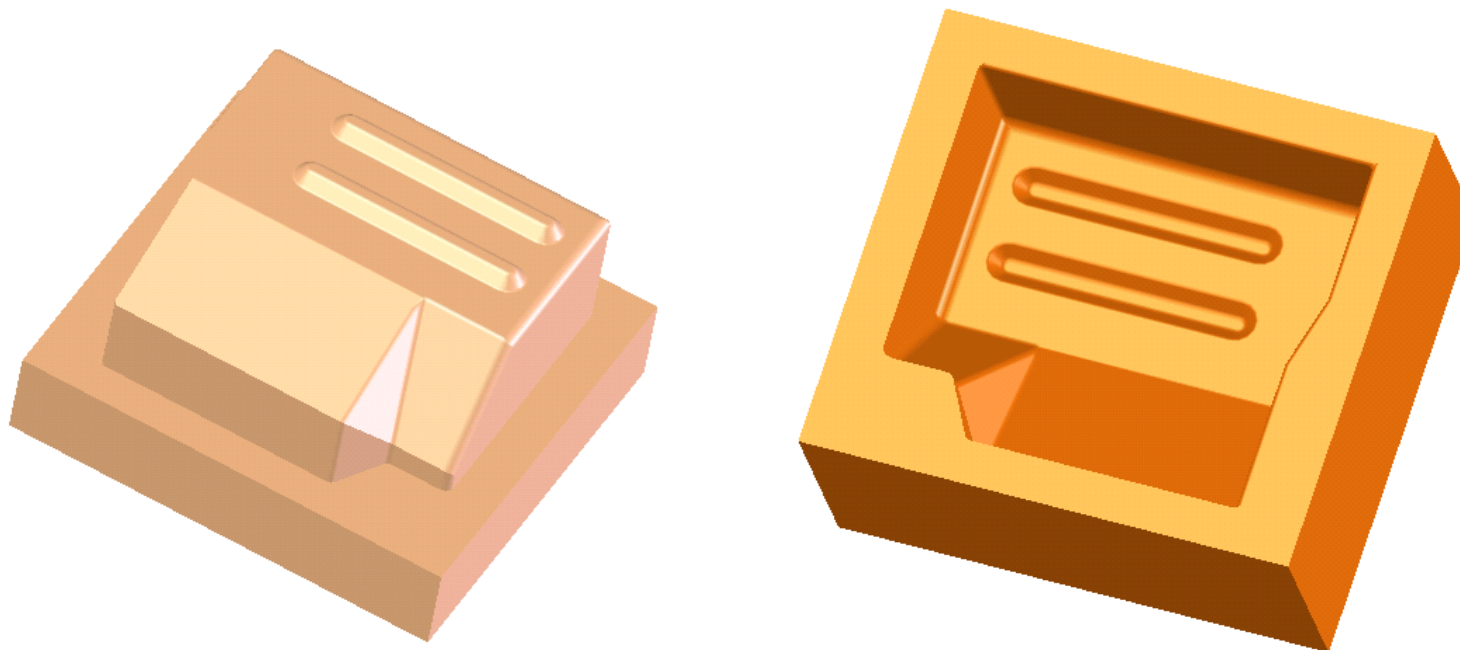

Ký hiệu (Code)
K03-02-16-04

Tên chi tiết (Name of autopart)
KHUÔN TAI MÓC

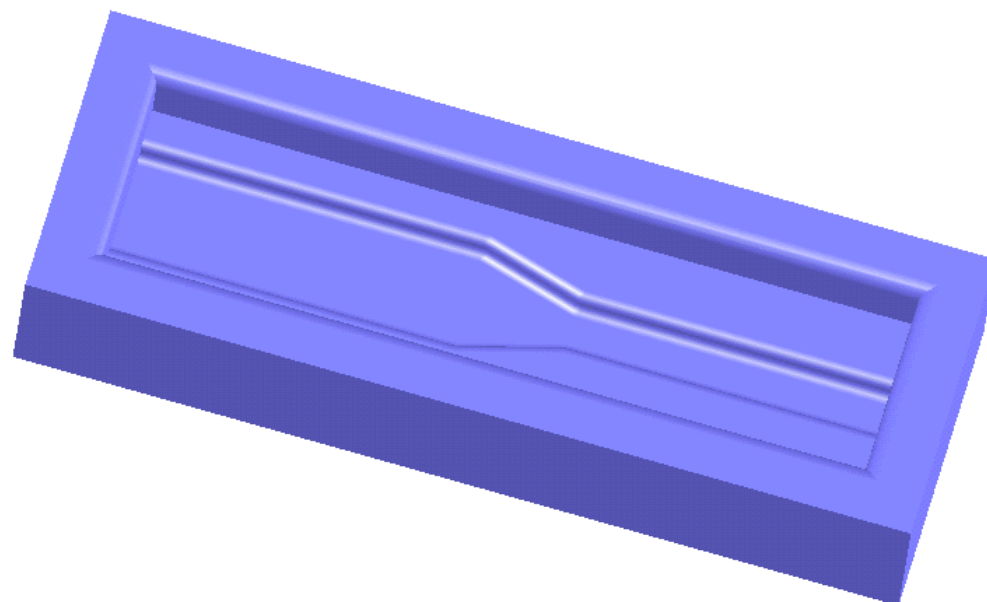
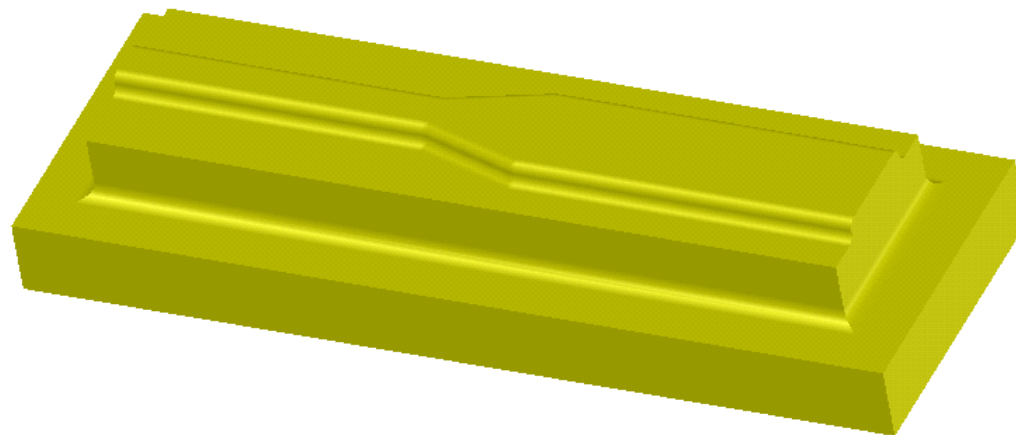

Ký hiệu (Code)
K03-02-17-00

Tên chi tiết (Name of autopart)
KHUÔN BAO NGOÀI BÁNH SAU TRÁI

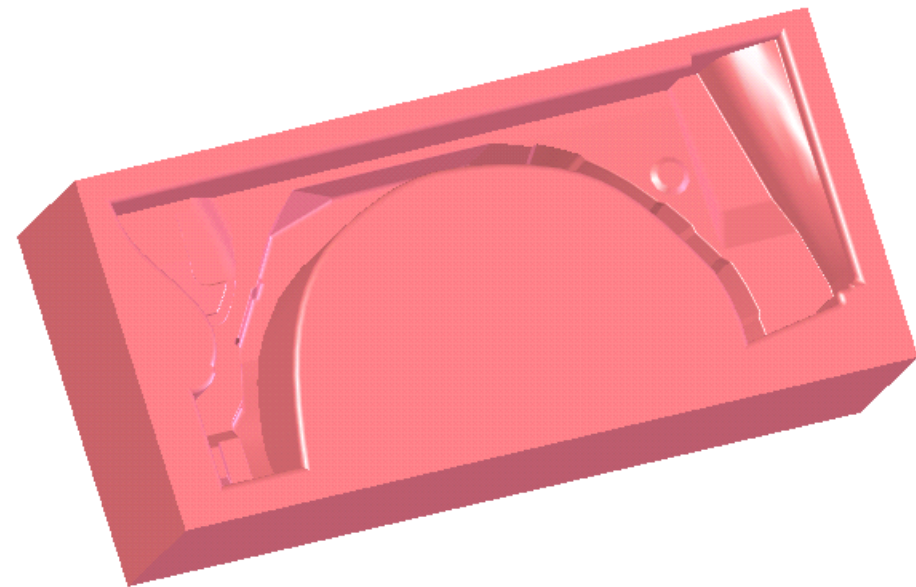
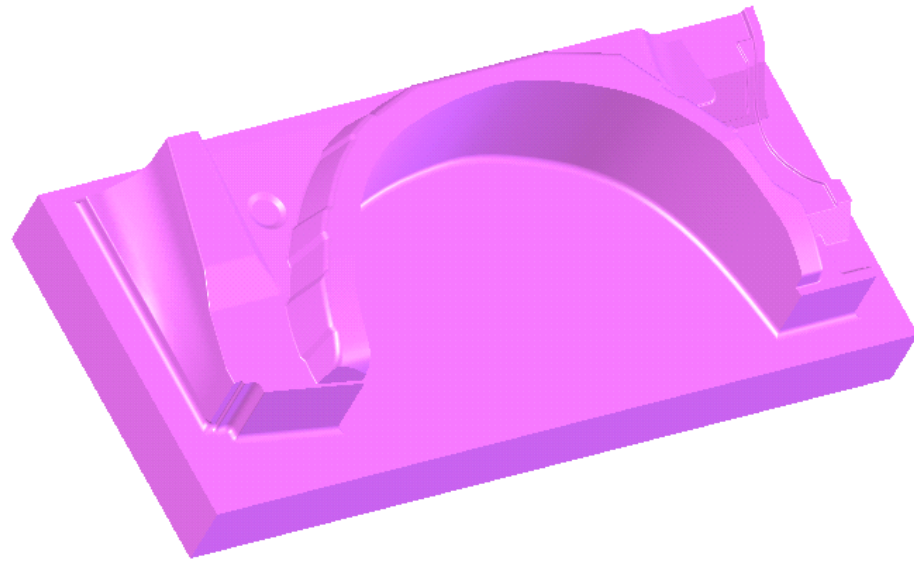

Ký hiệu (Code)
K03-02-17-03

Tên chi tiết (Name of autopart)
KHUÔN TẮM CÁCH

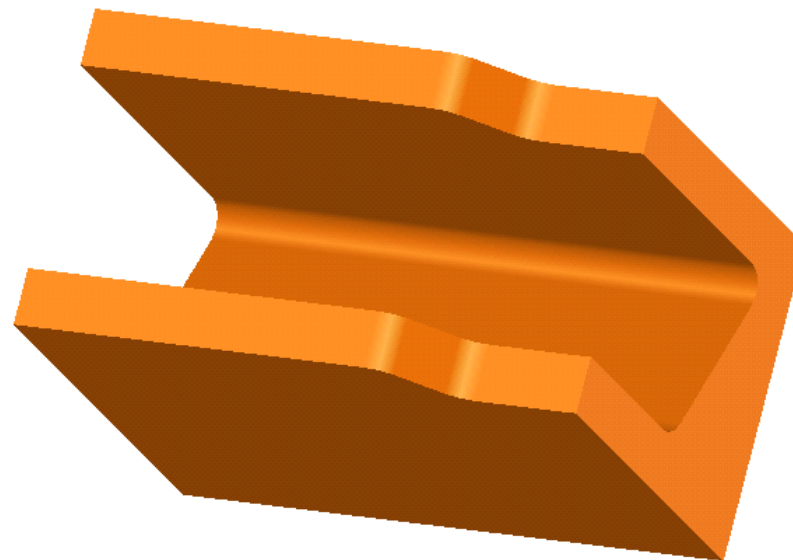
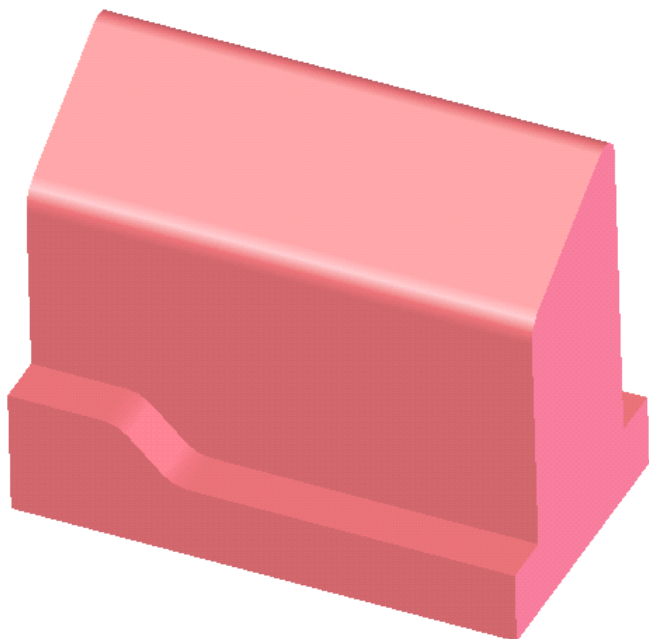

Ký hiệu (Code)
K03-02-17-03

Tên chi tiết (Name of autopart)
KHUÔN TẤM CÁCH

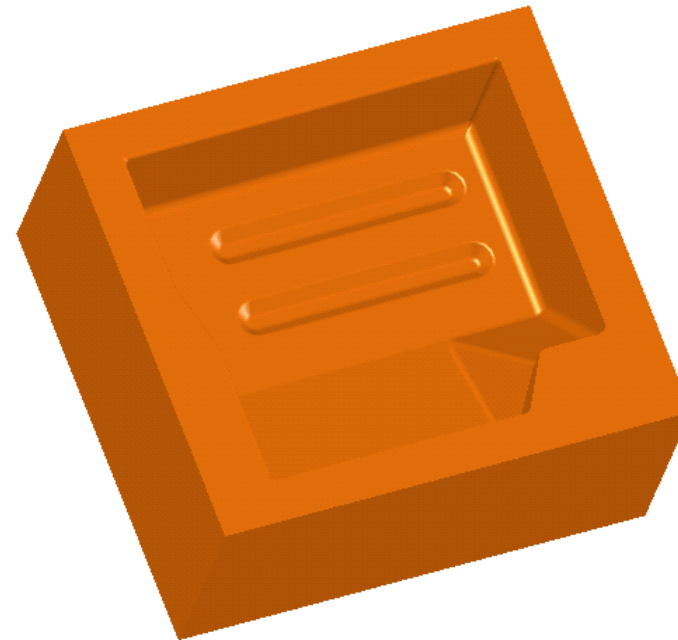
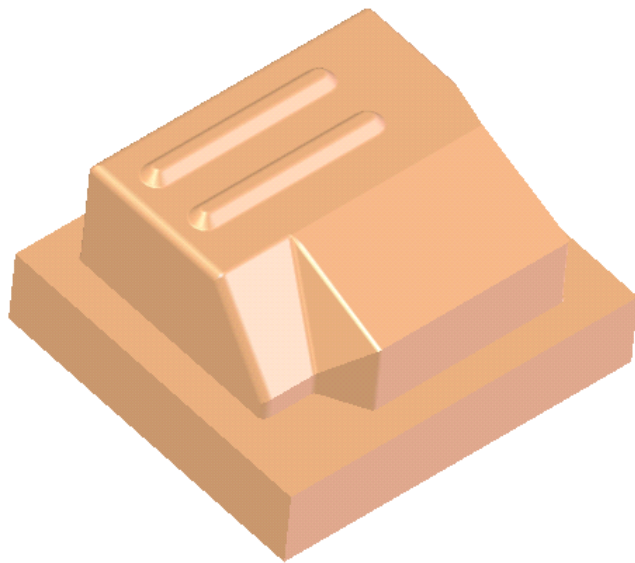

Ký hiệu (Code)
K03-02-17-04

Tên chi tiết (Name of autopart)
KHUÔN TAI MÓC

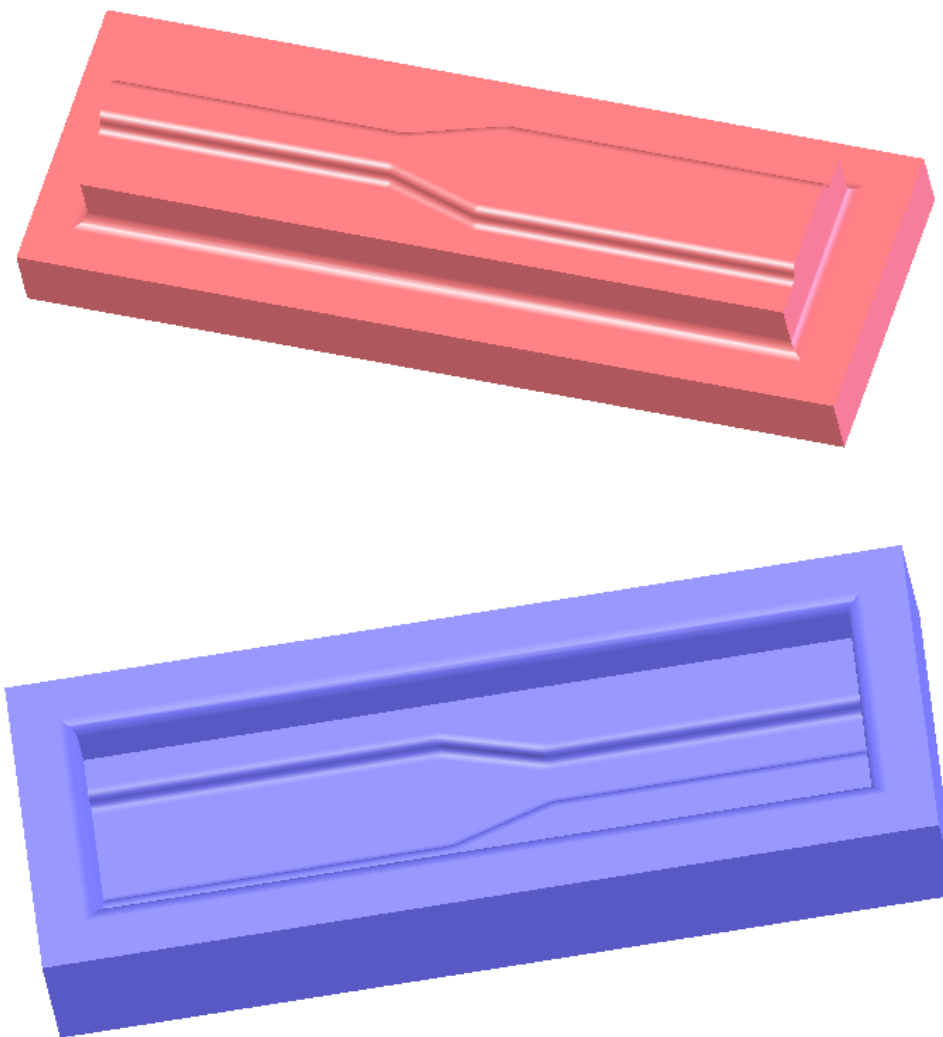

Ký hiệu (Code)
K03-02-18-00

Tên chi tiết (Name of autopart)
KHUÔN MÓC DƯỚI GIỮ BÁNH XE DỰ PHÒNG

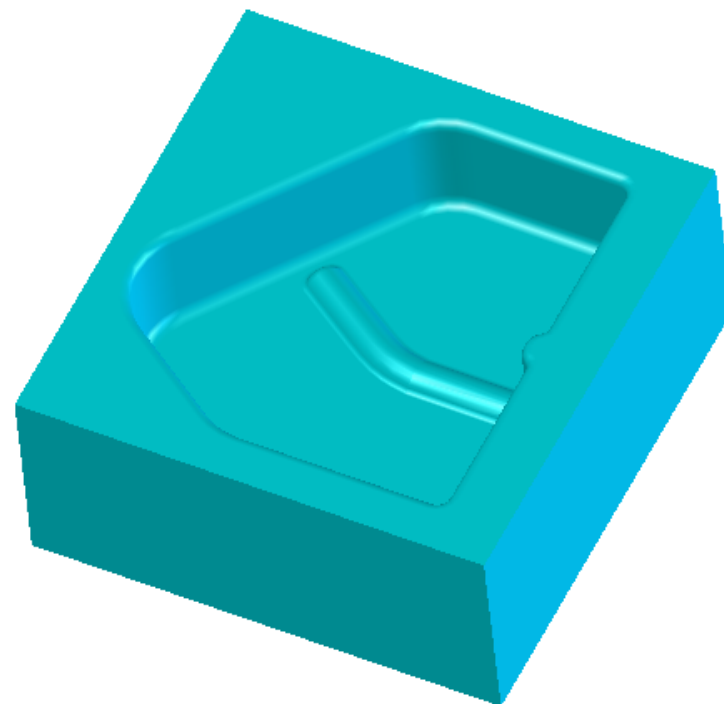
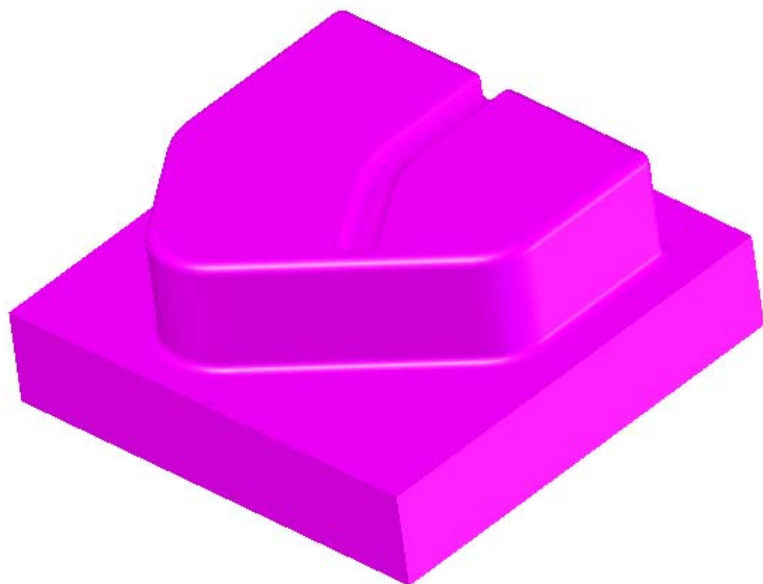

Ký hiệu (Code)
K03-02-19-00

Tên chi tiết (Name of autopart)
KHUÔN TẤM SÀN TRÁI BUỒNG ĐỘNG CƠ

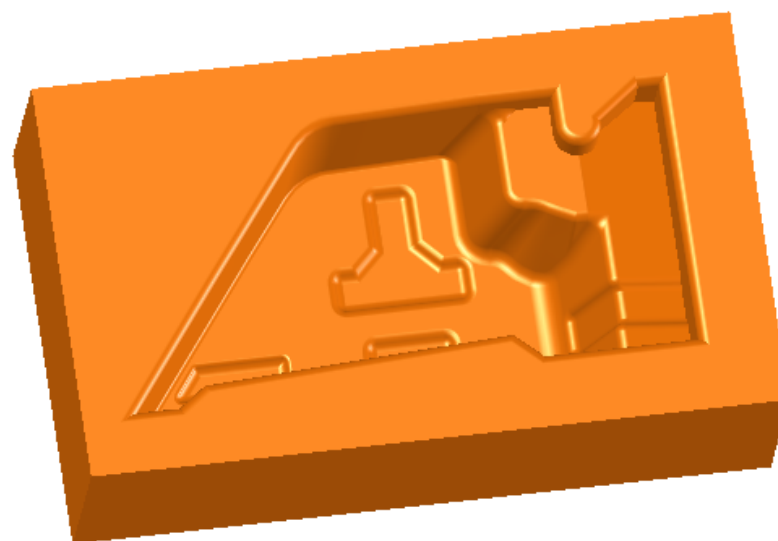
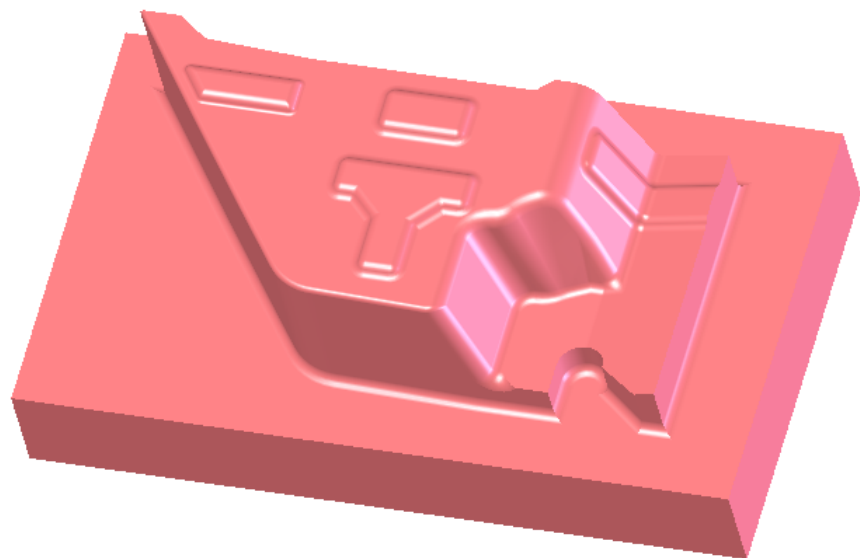

Ký hiệu (Code)
K03-02-19-01

Tên chi tiết (Name of autopart)
KHUÔN MIẾNG ĐỆM

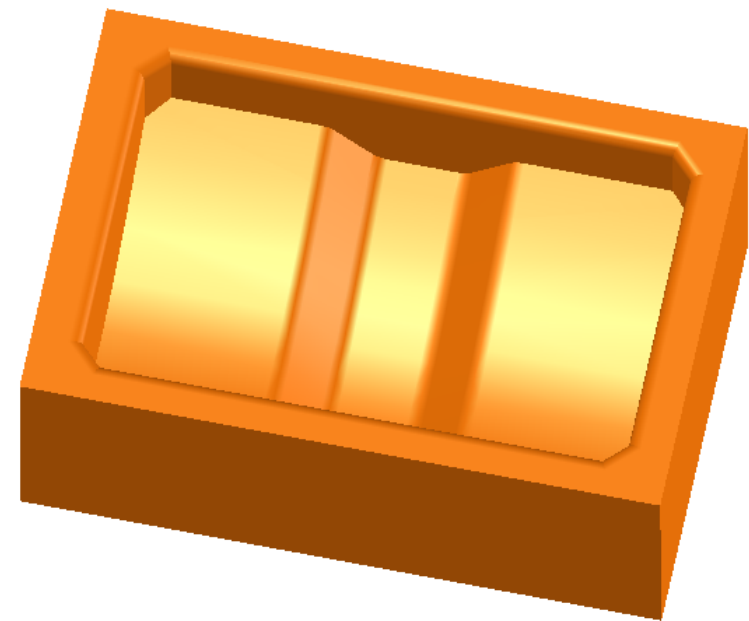
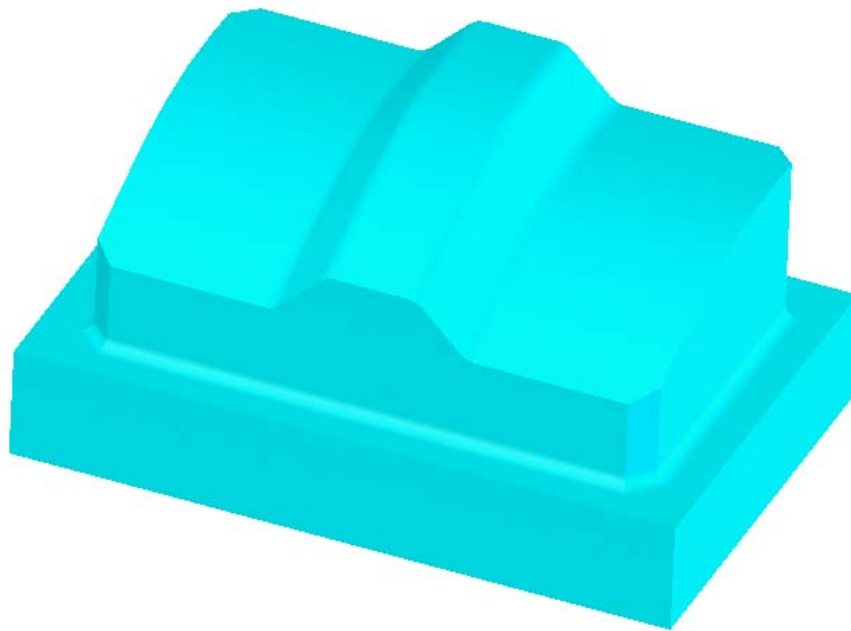

Ký hiệu (Code)
K03-02-20-00

Tên chi tiết (Name of autopart)
KHUÔN TẤM SÀN PHẢI BUỒNG ĐỘNG CƠ

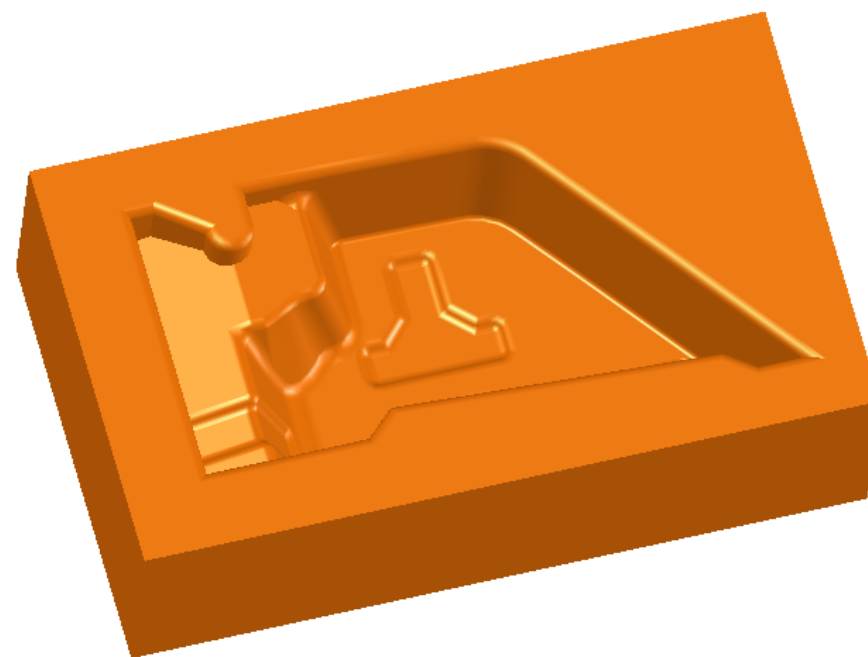
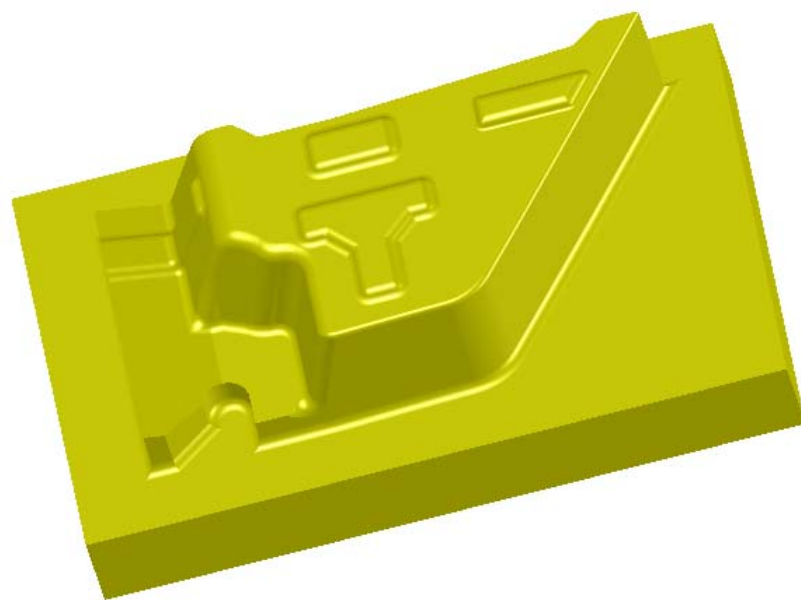

Ký hiệu (Code)
K03-02-20-01

Tên chi tiết (Name of autopart)
KHUÔN MIẾNG ĐỆM

